

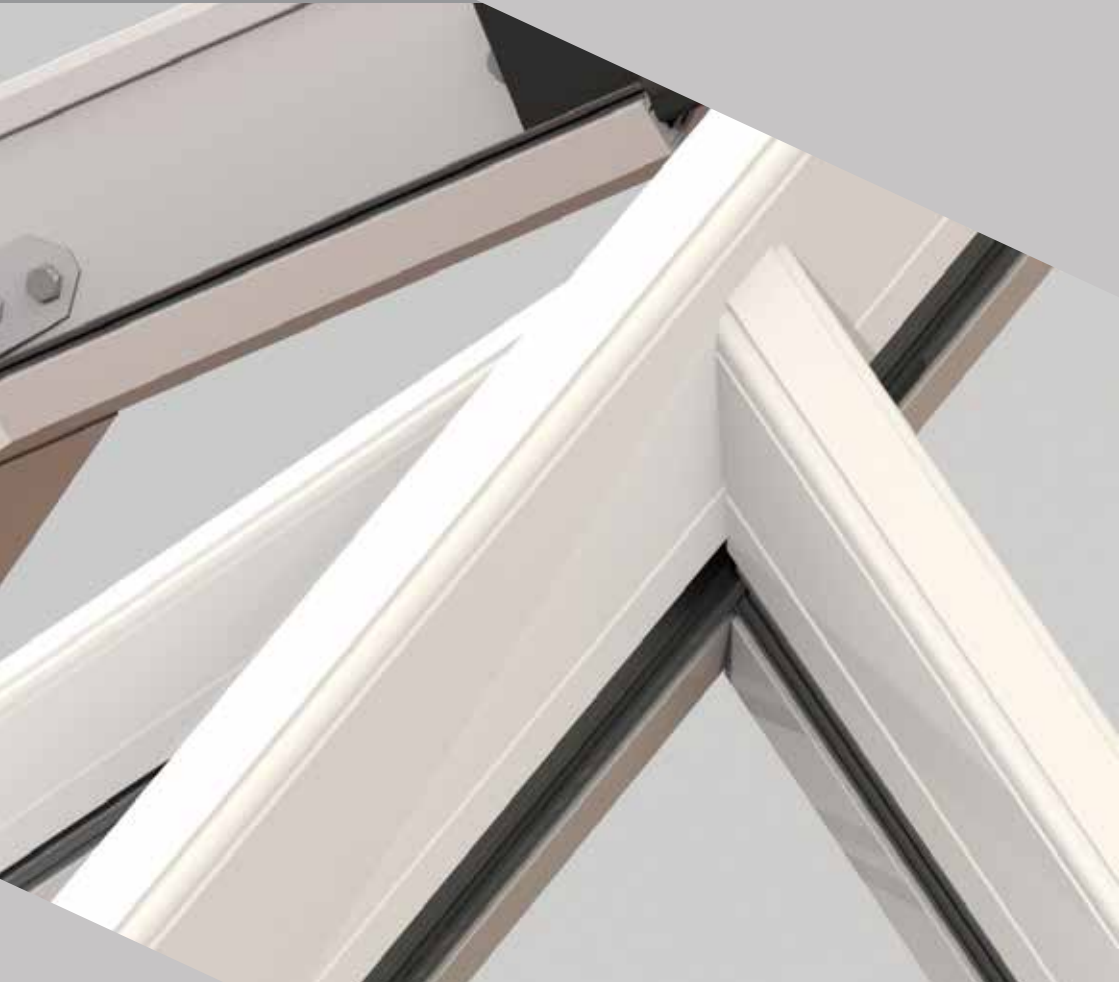

WENDLAND

R O O F S O L U T I O N S



Installation Guide

Wendland Mk5 Roof System

**Thank you for choosing the Wendland roof system.
This guide is designed to make fitting as straightforward as possible.**

Before you commence installation of the roof, please;

- 1) Take a moment to read these two introductory pages before reading the rest of this guide.
- 2) Do not fix the frames down at this stage – only temporarily ‘pin’ the frames to the house wall (one fixing each side) to allow the conservatory to ‘float’.

Wendland have been making conservatories since 1995. We have continued to invest to improve the features that the homeowner will appreciate and that should make your life easier. Any feedback - positive or negative - is welcomed so we can make our systems even better.

**Please contact the Tech Support Team on 01200 452 318
or email customerservice@wendland.uk.com**

CONTENTS

Section 1	Pre-installation checks	4
Section 2	Edwardian roof installation & gutter	5
	Bi Fold Support Beam Fitting Guide	6
	Valley installation	7
	Gutter Installation	8
	Edwardian Installation	10 -15
Section 3	Slimline Ridge Installation	16
Section 4	Tie bars	20
Section 5	Box gutter installation	21
	Box gutter jointing	21
	Box gutter support	21
	Box gutter raised back	22
	Reinforced box gutter	23
Section 6	Valley Installation	24
Section 7	Lean-to installation	25
Section 8	Gable installation	26
Section 9	Hip lean-to installation	27
Section 10	Conservaflash	28
Section 11	Muntin bar installation & Capping removal	29
Section 12	Gutter Cover installation	30
Section 13	Internal Pelmet installation	35
Section 13	Plaster boarding & Plastering	46
Section 13	Bolster Bars	47
Section 14	Gable	55
Section 15	Valley	57
Section 16	Integral Box gutter	61

ALL box gutters (especially those with tie bars or joints) MUST be supported.

We recommend several types of support for box gutters including brick piers. See pages 22-23 for details of our solutions. Fitting a conservatory box gutter without adequate support will lead to structural failure. Please take the correct steps BEFORE installation.



Scan the QR code to watch a Wendland Glass Roof installation.

TOOLS REQUIRED



Eaves to frame fixings, host wall fixings and ridge top cap flashing trim screw not supplied.

General points

Care should be taken when handling components that are seen by the homeowner, as surfaces may be scratched if not handled with care. Choose a suitable area for unpacking the components and always check them before fitting. Any claims for missing or damaged parts are only accepted in line with our standard terms and conditions of sale.

Health & safety

Site safety is paramount. The Construction (Design & Management) Regulations 2015 apply to the whole construction process, on all construction projects from concept through to completion. Compliance is required to ensure construction projects are carried out in a way that secures health and safety. The installation company shall be responsible for the safety of all of the fitting team, the customer and members of the public.

The Surveyor should have carried out a risk assessment to reduce risk on site and this should have been discussed with you prior to starting.

Please use safe working platforms and ladders that comply with BS EN 131. Always use equipment in line with manufacturers recommendations. Personal Protective Equipment – such as goggles, mask and ear defenders – should be used when, for example, grinding out for the flashing.

Careful consideration should be given to the safe disposal of all packaging – our packaging is predominantly made from recycled materials and can be readily recycled.

Product

The roof kit is supplied with a location plan, part check list and this installation guide. The location plan is used to match individual components to their respective position on the roof. Our numbering convention always starts at the top left, against the house wall as you look from outside the conservatory back at the host wall.

The majority of aluminium and PVCu components contain identification codes, usually by inkjetting or labelling – should you need to re-order a part this should help. Please ask for a copy of our product guide to keep in the van, which will give you further assistance with future identification.

Sealing

It is important to use the correct sealant when sealing the roof.

1. For roofs glazed with Polycarbonate (or standard sealed units) a low modulus neutral cure brand of silicone must be used
2. For roofs glazed with Conservaglass or other true ‘self cleaning’ glass, then MS Polymer sealant such as Rotabond 2000 must be used.

Sealed Units

All protective handling tape must be removed prior to installation. For the correct selection of sealant please see above

The Superstructure

Check the Dwarf wall or Plinth for being level all round. Ensure that all frames which about the host wall are vertically plumb, which will then allow perfect alignment with our eavesbeam. Before starting to install the roof, please check the condition of the host wall and whether it's plumb – depending upon what you find, these conditions can seriously affect the final integrity of the roof.

PRE INSTALLATION CHECKS



Unpack the roof vent sash and assemble, see section 2. If possible, do this in the factory the day before.

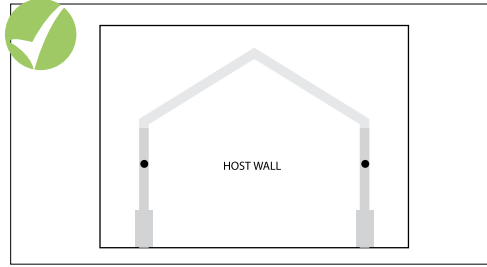

At this stage do not fix the frames down - pin only to the house wall (one fix per side) to allow the conservatory to 'float'.



Take the glazing bars from the roof pack and check the w grip clip are fitted (the clips are always at the top of the slope). On the eaves beam check that there are the correct amount of twin and single bolts and that the glazing support trim is fitted.



Attach the glazing bar end cap fixing blocks - as access restrictions (box gutter situations) may prevent easy attachment later.

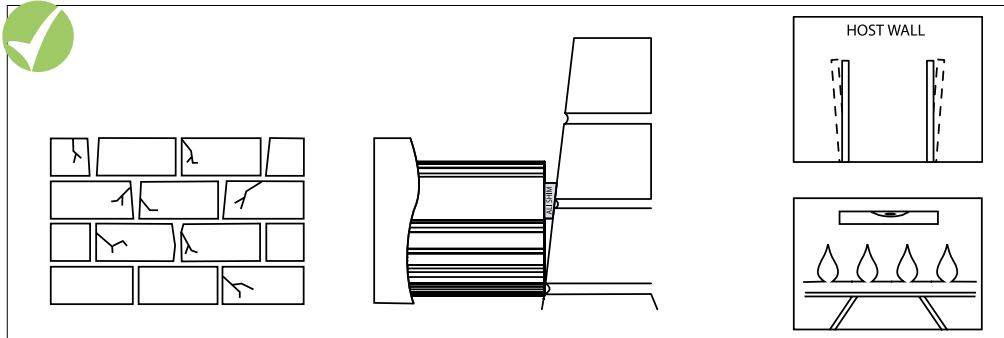

Check the condition of the host wall as this may affect the quality of the final installation. Check the host wall is plumb - any running in/or out should have been accounted for by the surveyor. If not, the ridge and starter bars may require packing out with aluminium shims. Correct alignment in this area is critical to a successful installation - Plumb frames/level ridge.

Only use the specified fixings - never be tempted to substitute alternative sizes/gauges.



MS Polymer

- Conservaglass
- Self cleaning glass



Low modulus neutral cure

- Polycarbonate glazing
- Standard sealed units

4 Use the correct sealant

EDWARDIAN INSTALLATION

FITTER TIP - VIC FIXING KIT

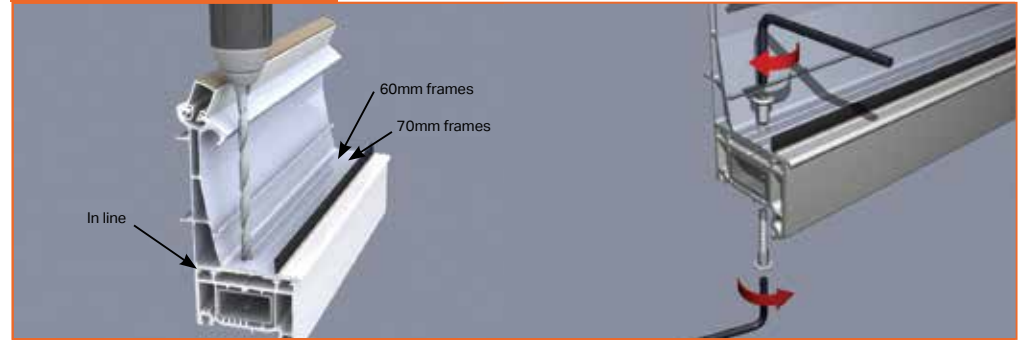

When using the Victorian Fixing Kit drill a 10mm hole through the base of the eaves beam and completely through the head of the window frame. Ensure that both sides of the 10mm hole are accessible for Allen key fixing. Use a 5mm Allen Key to tighten the fixings. The eaves beam should be fixed at 450mm centres and within 200mm of each corner. **THIS IS THE RECOMMENDED FIXING METHOD**

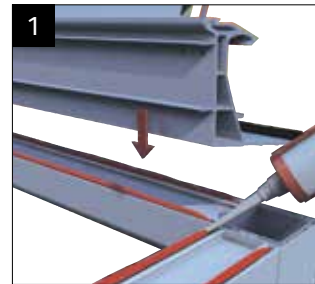

1 Apply a continuous bead of silicone to the front and rear inner legs of the window frames. Fit the initial piece of eaves beam ensuring that the inside face of the eaves beam is flush with the inside face of the window frame.

Please note: Ensure that the under gutter trim is fitted to the eaves beam and all bolts are in situ prior to fixing to the frames.

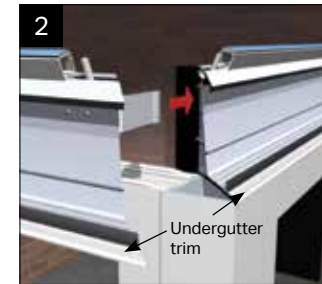

2 Place the next section of eaves beam into position, by slotting the corner cleat on the adjacent piece of eaves beam into the first piece.



3 Using the pre-drilled pilot holes, drill two 4.5mm holes through the corner cleats.



4 Securely fit the two M5 x 12mm tapitite screws.

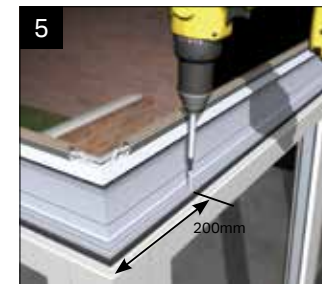

5 Securely fit the eaves beam to the frames using for example, 38mm x 4.8mm screws in the position shown. Fix down at 450 centres and within 200mm of each corner. For 60mm frames use the inner eaves extrusion line and outer line for 70mm frames. Always screw down. (Not supplied)



6 Once the eaves beam is secure, run a bead of silicone down the joint where the eaves beam sections meet and where the eaves abuts the host wall.

SECTION 2 GUTTER INSTALLATION

Fig. 1

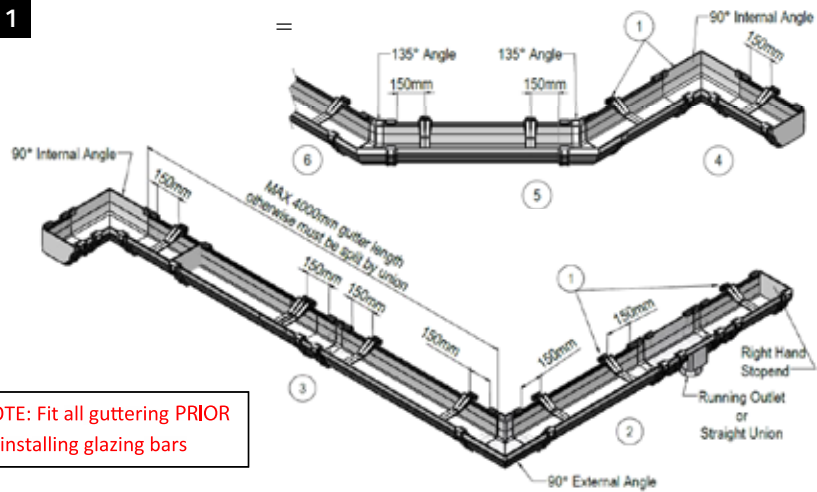

NOTE: Fit all guttering PRIOR to installing glazing bars

IMPORTANT:

NOTE: DO NOT push fit any union onto gutter as this can result in leaks.

Ensure all lengths of gutter fit to the marked insertion line seen in all unions and box gutter adaptors. (See Fig. 2)

Ensure to lubricate all rubber seals prior to inserting the gutter.

Must not slide gutter into union must always squeeze to prevent the gasket being moved. Watch a video tutorial by scanning the QR code in step 2b.

DO NOT Silicone Seal, this would prevent expansion/contraction.

If the gutter is not allowed to freely expand, distortion can occur.



1 Gutter brackets

Measure & fit all gutter brackets supplied with the kit at maximum 750mm centres and maximum 150mm from Unions and all stop ends (See Fig. 1). To fit the bracket, push into the gutter channel and rotate it clockwise to engage.

Position valley 90° internal angle if required. (See Fig. 1 general finished assembly)

NOTE: It is difficult to fit valley 90° Internal if the valley is already installed.



Insert gutter assembly and squeeze into position. Scan the QR code to watch a video tutorial. Ensure the back and front edges of the gutter are fully clipped into the bracket.

NOTE: DO NOT push fit any union onto gutter as this can result in leaks.



2a Pre build up gutter assembly

Position the external 90° gutter angle onto the eaves beam followed by any union/outlet. Then measure between the insertion lines (clearly marked on the union/outlets) and cut the gutters to length. **Ensure to lubricate all rubber seals prior to inserting the gutter into position** then snap the integral clips fitted to the unions/outlets over the gutter.

2c



Take the pre-built gutter assembly, overhang it from the end of the wall and squeeze the gutter into the gutter brackets. Once the full length is supported by the brackets, slide the assembly towards the host wall until flush.

3



Assembly & cut gutter to size – if over 4000mm span then the gutter must be split by a straight union. Insert gutter assembly and squeeze into position (see step 2). **DO NOT** slide gutter into union must always squeeze.

NOTE: Sliding can result in damage to the seal

4



Build up gutter assembly; gutter & 135° union. Snap the integral clips on the unions over the gutter and repeat similarly to step 2b.

NOTE: Remember to work to the insertion lines.

5



Build up gutter assembly; gutter & 135° union. Snap the integral clips on the unions over the gutter.

Insert gutter assembly into brackets using "step 2b" assembly methods. 135° angle to overhang then. 135° angle to overhang.

Slide gutter assembly towards 90° union and then snap the integral clips on the unions.

NOTE: DO NOT slide gutter into union must always squeeze gutter into position.

6



This should be the final step in the gutter system installation for a Georgian or Victorian, as the opposing side will be repeated by the previous steps within this guide. The gutter will essentially meet up at this step. Cut gutter to length and insert gutter assembly into brackets using "step 2b" assembly methods.

NOTE: DO NOT slide gutter into union must always squeeze gutter into position.

Fig. 2

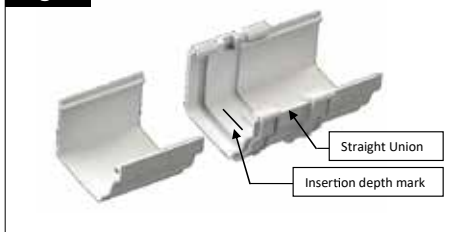

Insert gutter assembly and squeeze into position, critical to locate the back edge of each section of gutter into the slot in the gutter bracket first.

NOTE: DO NOT push fit any union onto gutter as this can result in leaks.

SECTION 2 GUTTER INSTALLATION

SECTION 2
EDWARDIAN INSTALLATION

If you are fitting the slimline ridge, please go to page 16.



Support the ridge at the host wall and crown point. Ensure the spider has been pre drilled, glazing fascia and glazing pocket have been fitted.

Fitters Tip: Pre-stress the ridge by supporting it 10mm higher than specified at the crown point.



Offer up the first hip bar to the spider, insert the location pin through the spider arm fixed to the hip. Locate the pin into the pre drilled relevant hole on the spider.



Locate the hip onto the bolts at the eaves. Loosely secure with flanged nuts. **Repeat these steps until all hip and intermediate bars that meet the spider, have been positioned.**



Continue to support the ridge and offer up the starter bars at the host wall. Locate on to the single bolts at the ridge and eaves.



Secure with flanged nuts at ridge and eaves.



Continue to support the ridge and offer up the rafters that meet the ridge. Locate onto the double bolts at the ridge and bolts at the eaves.



Secure with flanged nuts at ridge and eaves.



Using the location plan, repeat these steps until all rafters that meet the ridge have been fitted in the correct position and have been secured.



Fitting the jack rafters, ensure the jack rafter brackets have been fitted to the jack rafter prior to installation.



Offer up the jack rafter on to the hip and locate on the bolts at the eaves. **The jack rafter bracket should be angled towards the specified hip**



Align the bracket with the pre drilled holes on the hip bar, pass two M6 x 20mm through the holes and secure with flanged nuts.



If two jack rafters are aligned either side of the hip, a M6 x 25mm bolt is required to fix both sets of brackets through either side.



Once fixed, minor adjustment maybe required to align the undercladding flush with the under side of the hip, this can be done by adjusting the bolts to suit. **Repeat these steps until all jack rafters are fitted. Fully secure all rafters and hips.**



Ensure all gutter runs have been fitted and that all glazing bars are fully secured.



Check the window frames are plumb.



Ensure the ridge is level.



Check that the pitch of the roof is correct. Your Surveyor should have provided a drawing/a copy of the roof confirmation which displays the pitch.



Check that the starter bar and first transom bars are parallel.

SECTION 2
EDWARDIAN INSTALLATION

SECTION 2

EDWARDIAN INSTALLATION



24 Drill the starter bars/masonry within 200mm of the ridge and eaves beam plus at least one more equidistant between the two. Pack out to support the starter bar behind each fixing before fitting the correct masonry anchor.



25 Drill through the holes on the ridge fixing bracket and secure with the correct masonry anchor. **Now fasten the frames to the host wall and the dwarf wall.**

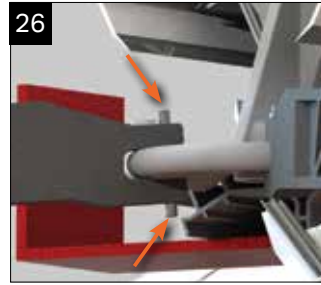

26 Tighten the grub screws on the spider arms to fully secure the hips at the spider. **(Minor adjustment can be done using the grub screws if hip bars are slightly uneven)**

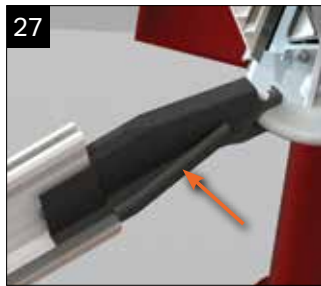

27 Fit the spider arm covers with the glazing seals inserted.

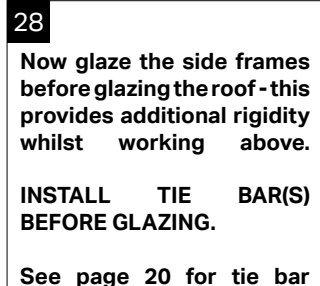

28 **Now glaze the side frames before glazing the roof - this provides additional rigidity whilst working above.**

INSTALL TIE BAR(S) BEFORE GLAZING.

See page 20 for tie bar install details.



29 Take the glazing end profile and run continuous bead of sealant (appropriate for glazing) immediately behind the co-extruded gasket (along the full length). Now seal the space between the glazing end profile and the sealed unit (see inset) at each end (DO NOT DO THIS ON POLY ROOFS).



30 Snap off appropriate handed glazing stop. Place this into the base of the glazing bar.



31 Snap off a gromet from the kit, this will slot over the upstand on the glazing stop. **Repeat spets 35 & 36 for all glazing bars on the roof.**

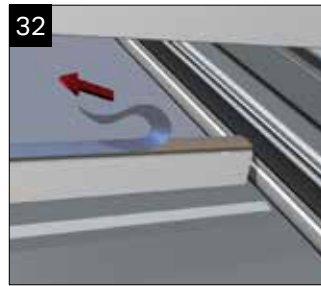

32 Tease the 'tail' of the glazing support trim tape free (ready to be pulled away when the sealed unit is finally in position).

SECTION 2

BI-FOLD SUPPORT BEAM FITTING GUIDE



Fitting bi-fold bolster to the eaves.

PRE-FITTING NOTES:

9mm fixing holes should be pre-drilled in the eaves beam 50mm in from each end of the bolster and at a maximum of 300mm centres.

The bolster is to be fitted between corner posts with frames below. If only one side is bolstered, none bolstered sides will require a 70mm frame add-on to allow all frames to be manufactured to the same height.

The bolster is not a symmetrical component so must be positioned in the correct orientation to allow for the bolts to align correctly and the bolster to sit flush with the eaves beam.

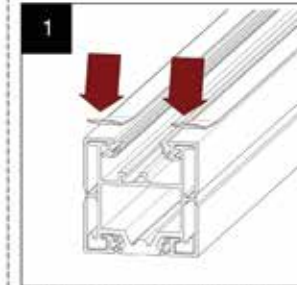

1 Apply sealing tape to the bolster. This may have been pre-applied.

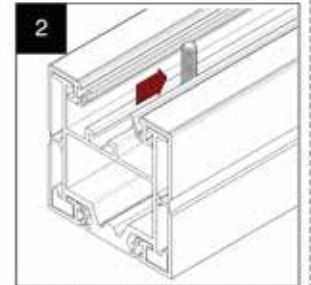

2 Position bolts to align with the holes drilled in the eaves beam. Accurate positioning of these fixings allows for easier fitting, it would be advisable to mark these positions using the eaves as a template.

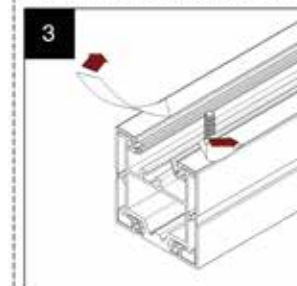

3 Peel back a small tab of the sealing tape protective film. Ensure the 'tail' is accessible from the side of the bolster.

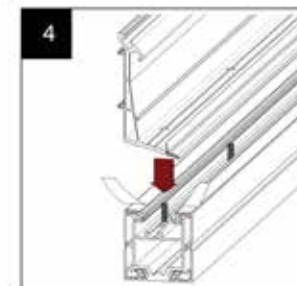

4 Lift the eaves beam onto the bi-fold support beam ensuring the bolt channel is positioned to the inside and taking care to align the drilled holes with the bolts.

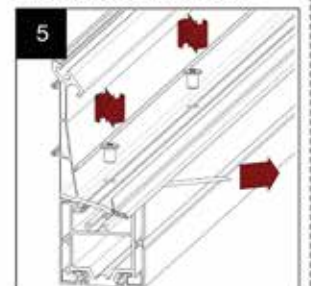

5 Using the socket flange nuts provided locate them on the bolts. Once all nuts have been located on their corresponding bolts fully peel back the sealing tape film on both sides and tighten down the nuts.

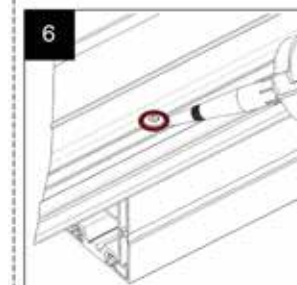

6 Using sealant apply around the heads of the fixings ensuring a water tight seal.

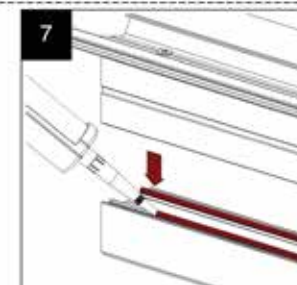

7 Apply sealant to the frames to ensure a weather tight seal between the bolster and the frames. Once the sealant has been applied lower the bolstered eaves onto the frames.

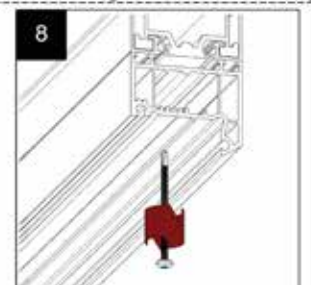

8 Fix the bolster to the frames using self drilling screws through the frames and up into the bolster. If steel reinforcement is included in the frames it may require pre-drilling.

SECTION 2 VALLEY INSTALLATION

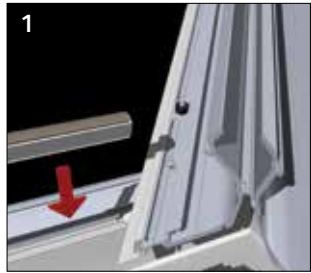

1
Cut and re-fit the glazing support trim, where the valley meets the eaves beam.



2
Now run a continuous bead of suitable silicone down the entire length of the aluminium valley profile, at the point of the hinged connector in the centre.

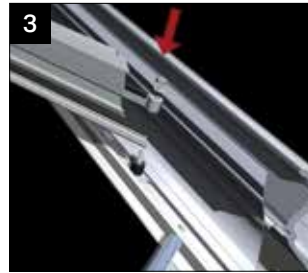

3
Using the location plan provided, assemble the various glazing bars onto the valley. Use the washers and nuts provided to ensure a robust joint is created.

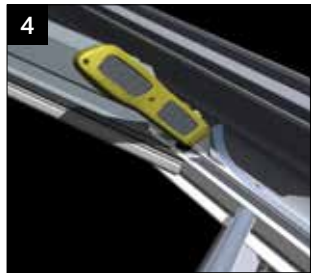

4
Fit the double sided sealing tape to each of the valley wings. Tease one end of the protective tape loose, crease it about 50mm in from the end and fold over ready to extract once the glazing panels are laid in position.

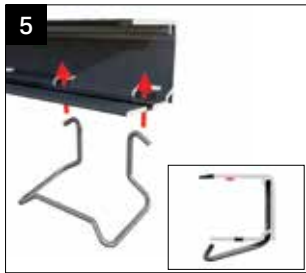

5
To retain the glazing to the valley wing, fit 2 wire clips (100mm from each end of the profile). The 'hooked ears' locate behind the lip detail as shown. Apply a continuous bead of sealant (MS Polymer to self cleaning glass). See Step 37 on page 16.

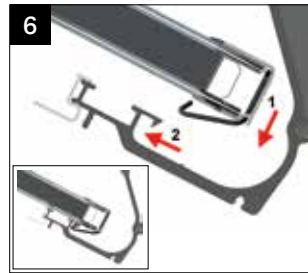

6
Place the glazing in its correct position (refer to location plan if in doubt). Position the end profile down into the valley as shown. With the glazing pressed flat against the valley profile and your fingers underneath, pull the glazing up into the rain baffle and allow the clip to 'lock' the glazing in place. Once properly fitted, the clip should lock into place as shown.

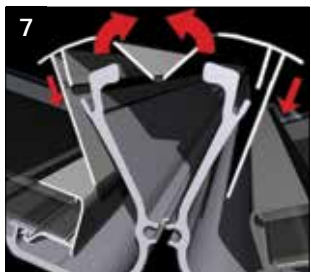

7
Fit the valley top cladding by folding to form an internal 'V' - then tap into the aluminium valley profile using a plastic hammer.

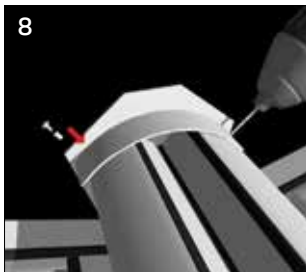

8
Fit the valley end cap using the two plastic rivets supplied.



9
The joint between the full and half ridge PVC top caps is sealed by the use of a capping connector. This needs to be trimmed to suit. Bed the capping on suitable silicone and fix using the plastic rivets provided.

SECTION 2 EDWARDIAN INSTALLATION

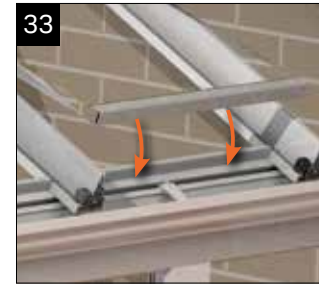

33
At this point the roof should be glazed. Any ridge support may be removed. Insert the glazing between the rafters ensuring that it is centralised.

If you are installing a roof vent installation guide



34
Ensure the glazing stop is pressed tightly up against the end profile. When in position use the fixings provided to fix the glazing stop down into the bar as shown.

Ensure clip offers maximum support to glazing at all times.



35
Once the roof has been fully glazed and glazing stops secured, work your way around the roof fitting the glazing bar top caps. These should be angled in at the ridge first before forcing the top cap down along the bar length. **Ensure to fully engage w grip clip.**



36
Knock the glazing bar top cappings on with a Deadblow hammer. Greater care is needed in cold weather. Keep all trims wrapped while fitting for protection.

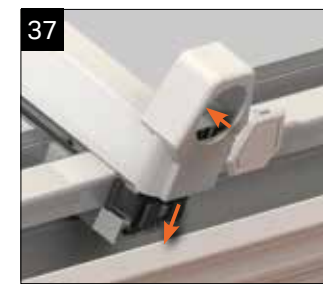

37
If you haven't fitted already, attach end cap fixing brackets. Fit the glazing bar end caps by sliding onto the end cap brackets. Push fit the insert into the end cap.



38
When fitting the jack rafter top caps, seal where the cap meets the hip top cap. The jack rafter top cap should sit tightly against the hip cap.

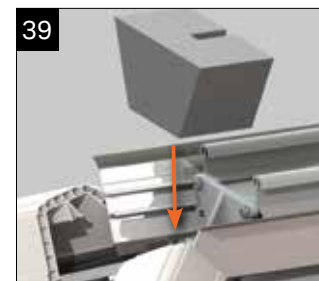

39
Once all the top caps have been fitted, insert the square foam block into the top of the crown point.



40
Take the semicircular foam piece and insert it into the front of the crown point. **This may require sculpting to suit the situation.**



41
Now fit the ridge flashing trim to the ridge top cap, apply a bead of silicone inside to secure.

SECTION 2
EDWARDIAN INSTALLATION

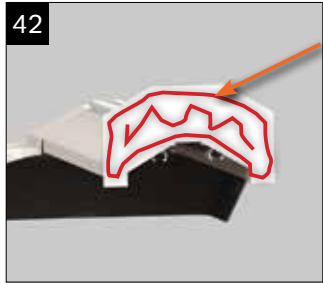

42 Apply a generous amount of sealant to the back edge of the flashing trim.



43 Fit the ridge top cap complete with flashing trim and crown cap to the ridge.



44 If cresting is specified, insert the cresting down the channel on the ridge top cap. This may require trimming to suit.



51 Fit the corner covers by trapping them behind the fascia sections. Insert the circular infill to finish.



45 The finial should sit over the crown point when cresting is fully inserted.

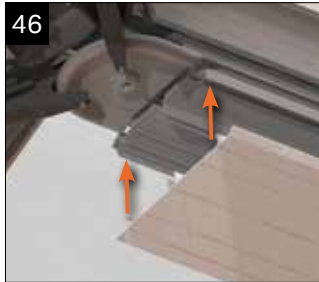

46 Moving inside the roof, fit the ridge undercladding to the ridge.



47 Insert the nylon threaded bar into the bottom of the spider.



48 Offer up the internal radius end cap, use the threaded bar and the retaining boss to secure the internal cap in position.
The threaded bar may require cutting to suit.

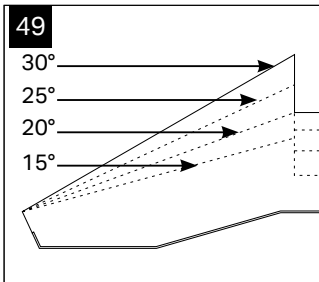

49 The internal radius end capping may require trimming to suit pitch (pitch lines are marked on the reverse of the internal radius end capping).



50 Fit the internal fascia claddings to the eaves beam, ensure the fascia corner packers are attached on the inside of the fascia at each corner.

SECTION 2
EDWARDIAN INSTALLATION

SLIMLINE RIDGE INSTALLATION



Support the ridge against the host wall centrally between the frames. Ensure supported throughout the assembly process until all components are fully secured.

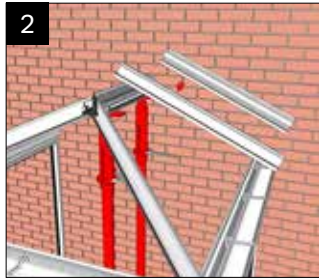

Fit and secure starter bars and side transoms to either side of the ridge. Locate on the bolts in both the eaves and ridge. Follow location plan for rafter position.

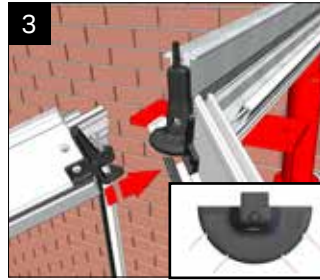

Fit hip bars by pushing the Spider arm hook over the Spider (aligning with outer marked notched positions) and then lowering onto the bolts in the eaves corners.



If specified, fix central rafter using the same method as the hips by pushing the Spider arm hook over the Spider.



Secure all rafters with the provided flanged nuts at both the ridge and eaves.



If jack rafters are specified, ensure the jack rafter brackets have been fitted to the jack rafter prior to installation.

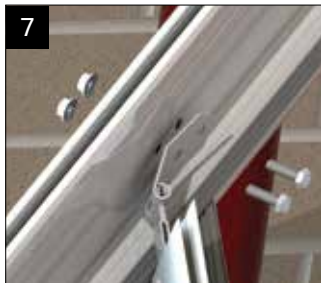

Align the bracket with the pre-drilled holes in the hip rafter, pass two M6 x 20mm bolts through the holes and secure with the provided flanged nuts.

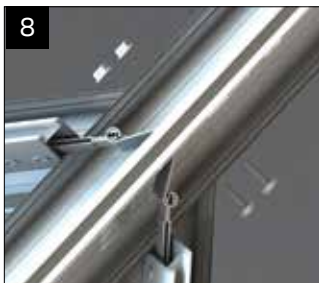

If two jack rafters are aligned either side of the hip, an M6 x 25mm bolt is used through both brackets and the pre-drilled holes in the hip. Secure with the provided flanged nuts.



Once fixed, minor adjustment may be required to align the under cladding flush with the under side of the hip, this can be done by adjusting the bolts to suit. Repeat these steps until all jack rafters are fitted. Fully secure all rafters and hips.

SLIMLINE RIDGE INSTALLATION

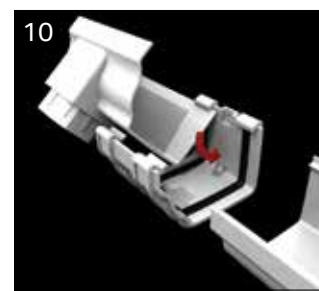

Build and fit gutter as per standard roof guide.



Check rafter centres are square and that the ridge is level. Check side pitches and that side frames are plumb.



Check that the starter rafter and the first rafters are parallel. Ensure all bolts at both eaves and ridge are fully tightened.



Drill the starter rafters/masonry within 200mm of the ridge and eaves plus at least one more equidistant hole between the two. Pack behind the starter bar and fix with an appropriate masonry anchor.



Drill through the holes in the fixing bracket and fix back using an appropriate masonry anchor. Fix frames.



Once level and pitches are correct, tighten fixing in the Spider arms using a 8mm socket bit. This locks the position of the arms.

Now glaze the side frames before glazing the roof. This provided additional rigidity whilst working above.

INSTALL TIE BARS BEFORE GLAZING.

See page 20 for tie bar install details.



Take the glazing end profile and run continuous bead of sealant (appropriate for glazing) immediately behind the coextruded gasket (along the full length). Now seal the space between the glazing end profile and the sealed unit (see inset) at each end (DO NOT DO THIS ON POLY ROOFS).



Snap off appropriate handed glazing stop. Place this into the base of the glazing bar.

SLIMLINE RIDGE INSTALLATION

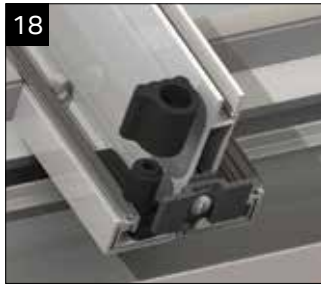

18 Snap off a grommet from the kit, this will slot over the upstand on the glazing stop. Repeat steps 35 & 36 for all glazing bars on the roof.

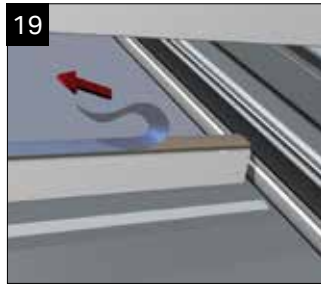

19 Tease the 'tail' of the glazing support trim tape free (ready to be pulled away when the sealed unit is finally in position).



20 At this point the roof should be glazed. Any ridge support may be removed. Insert the glazing between the rafters ensuring that it is centralised.



21 Ensure the glazing stop is pressed tightly up against the end profile. When in position use the fixings provided to fix the glazing stop down into the bar as shown. Ensure clip offers maximum support to glazing at all times.



22 Fit glazing according to location plan. Fit weathering shield around sides of ridge and hip rafters. The shield is cut to allow the material to fold around the profiles.

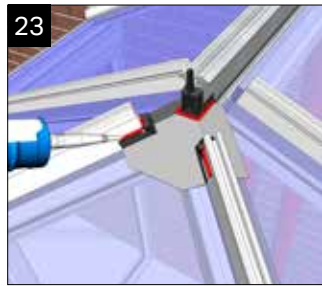

23 Once formed around the glazing, rafters and ridge, seal around these profiles.



24 Fit ridge capping by locating barbs in ridge profile and knocking down along its length. Use a timber drift and dead-blow hammer to avoid damaging the capping.

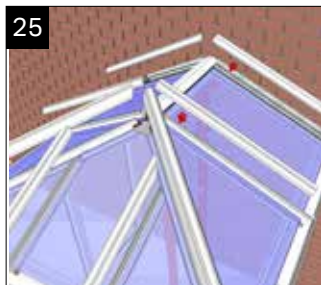

25 Fit all rafter top caps using the same method as the ridge cap ensuring that the transoms are pushed up against the ridge cap and that the cuts at the top of the hips are together.



26 When fitting the jack rafter top caps, seal where the cap meets the hip top cap. The jack rafter top cap should sit tightly against the hip cap.



27 If you haven't fitted already, attach end cap fixing brackets. Fit the glazing bar end caps by sliding onto the end cap brackets. Push fit the insert into the end cap.



28 Liberally apply sealant to the back face and the underside of the ridge wall flashing trim.



29 Lower wall flashing trim over ridge capping against the wall, pressing down and against the wall. Fold flashing over the trim or fit Conservafash into pre-cut slots in mortar lines following standard guide.

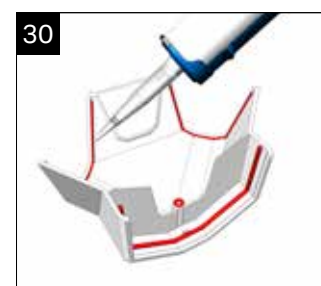

30 Apply sealant to the inside of the ridge endcap around the rafter openings and the dowel boss. If a central transom is specified, a cap with a transom cut will be supplied.



31 Fit ridge end cover locating on upstand on the Spider and over the hips, pressing down to seal.

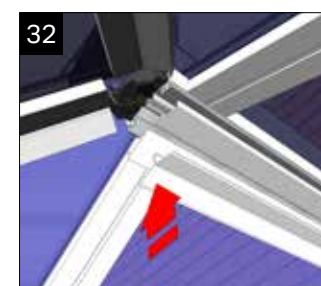

32 If the ridge claddings have not been pre-fitted, fit internal ridge under claddings by first fitting the outer profiles and then engaging the central profile in the barbs in the ridge. If a tie bar is required, the ridge should have been prepped and a bracket attached in line with the rafters

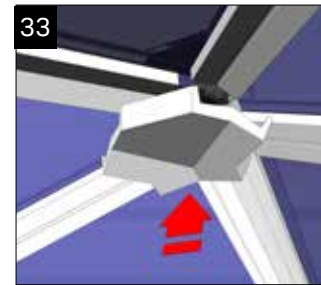

33 Fit the internal ridge end cover by engaging the bars into the mating barbs in the underside of the Spider.

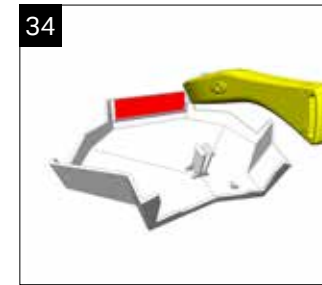

34 If a central rafter has been specified, using a knife or hacksaw, cut down the sides of the recessed area (marked in red). The tab should then break free by bending back and forth. Clean up the edges.

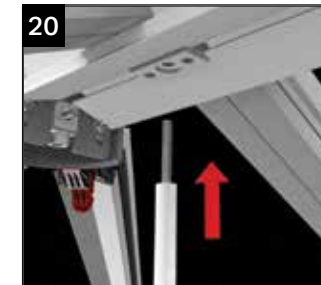

20 When fitting tie bar, threaded bar screws into pre fitted ridge block as shown.

SLIMLINE RIDGE INSTALLATION

SECTION 4 TIE BAR INSTALLATION

When a tie bar is specified, it is a structural requirement & must be fitted.

Prior to starting installation check the ridge is level and the side frames are plumb. THIS IS CRITICAL TO THE SUCCESS OF THE OVERALL INSTALLATION.

The position of the tie bar (s) will be indicated on the location plan provided whilst the tie bar brackets are already attached to the glazing bars.

Use this design when a tie bar and ceiling fan clash - two vertical drop rods.

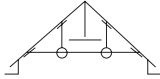

1a

Tie bar at finial
Insert the tie steel rod thread into the base of the spider. Measure the drop of the rod and cut to suit the position or the tie bar boss ring.



2a

Offer up the internal radius end cap, retain this using the tie bar ridge fixing cover and two self tapping screws provided. Cut the PVCu conduit to suit.



1b

Tie bar at ridge

Mark the position of the where the tie bar meets the ridge, fix the ridge fixing cover using the self tapping screws provided.



2b

Thread the tie bar rod into the ridge fixing cover. Measure the drop of the rod and cut to suit the position or the tie bar boss ring.

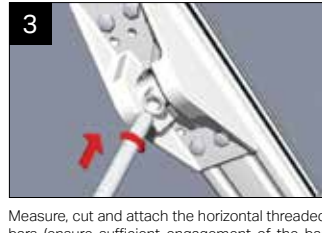

3

Measure, cut and attach the horizontal threaded bars (ensure sufficient engagement of the bar into the brackets) – it is essential that the tie bar boss is central. Take the boss ring, and loosely assemble the threaded bars to check they terminate inside the ring. Dis-assemble.



4

Insert the smaller diameter pieces of PVCu conduit inside. Offer into the boss ring and finger tighten the nyloc nut.



5

Offer up the horizontal pieces of PVCu conduit (large and small diameter).

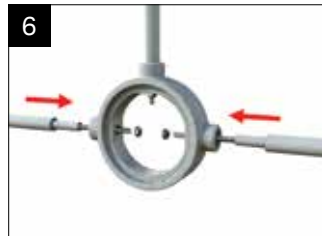

6

Insert threaded bar into the ring, and again finger tighten the nyloc nuts.



7

Now, finally check that the horizontal elements are level and the vertical element is plumb. CHECK THAT THE SIDE FRAMES ARE STILL PLUMB. Spanner tighten the boss nyloc nuts.



8

Offer up the two part rose cover, spin one half onto the threaded end of the other half.



9

Attach the bracket cover plates that hide the bolts.

SECTION 5 BOX GUTTER JOINTING

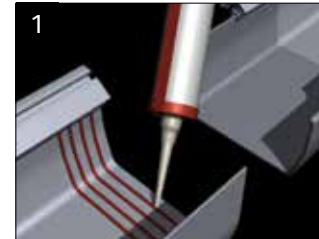

1

Thoroughly clean the mating parts using wire wool. Surfaces must be clean and grease free. Apply a generous bead of low modulus neutral cure to the pre-fixed internal sleeve along the entire face of the sleeve.



2

Drill through the top edge of the aluminium box gutter at 600mm centres. A fixing must be positioned within 50mm each side of the joint. Offer second half of the box gutter up to the internal sleeve and push firmly on. Fasten this second box gutter run to the host wall with masonry anchors suitable to the substrate. Ensure both sections are level and flush.



3

Drill 6.5mm holes through the box gutter and sleeve (at positions shown, ensuring both halves of the box gutter are flush together) and fix using the bolts, nuts and washers provided and in the order shown. Trim any excess off the bolt head before fitting the internal cladding as it may foul.



4

Check surfaces are dry, clean and grease free. De-grease if necessary. Heat both the sealing tape and the box gutter with a heat gun and position the tape over the joint. Press the tape firmly across the joint of the sleeve and the box gutter ensuring there are no air pockets.

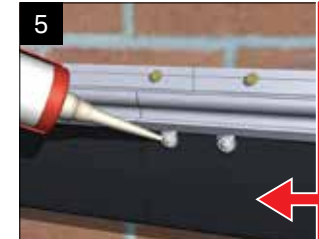

5

Now seal over all the exposed bolt heads, on the inside and outside of the box gutter.

ALL box gutters (especially those with tie bars or joints) MUST be supported.

We recommend several types of support for box gutters including brick piers. Fitting a conservatory box gutter without adequate support will lead to structural failure. Please take the correct steps BEFORE installation.

BOX GUTTER SUPPORT

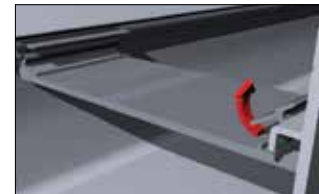

BOX GUTTER STRAP

165mm box gutters

These are supplied loose and MUST BE FITTED – they are a structural requirement of the roof. The straps must be installed within 75mm of glazing bar centres (when measured from centre of the strap to the centre of the bar). To install these straps, simply 'nip up' as shown.

265mm/special box gutters

Straps are factory welded into position.



GALLOWES BRACKET

These are available for 165/265 box gutters.

To install, notch out the insulation to ensure metal to metal contact between the extruded box gutter and gallows bracket. Offer up the gallows bracket and mark it ready to drill – always try to line up with the centre of a brick rather than a mortar joint. Drill the gallows bracket (the positions should be similar to the ones shown). Three masonry anchors should be used that are appropriate to the substrate.

Finally, notch out the undercladding, offer it into position and clip in.

Maximum centres are 2300mm. If the roof has a tie bar installed or a joint within the box gutter, then a gallows bracket should be installed directly underneath it.

BOX GUTTER SUPPORT



BOX GUTTER HANGER

165mm box gutters

If these have been specified by your company at the time of order they are supplied loose and must be fitted.

The structural requirement for the hanging brackets are 2 x hanging brackets (sat side by side) at a maximum span of 2300mm unless the roof has a tie bar or joint on the box gutter which should then be positioned in the same area.

Drill through the head of the hanger into the centre of the masonry, avoiding the mortar joint if possible. Use a masonry anchor suitable for the substrate. Lead flashing should be dressed down over the hanger, and snipped around the sloped leg. To attach it to the box gutter, simply 'nip up' as shown.

265mm box gutters

Hanger not available.

RAISED BACK BOX GUTTERS

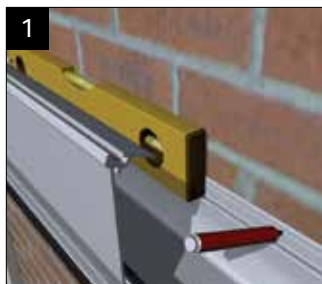

Offer the raised back or special box gutter into position. Carefully mark onto the aluminium leg (that abuts the host wall) the position of each fixing – use 600mm maximum centres.

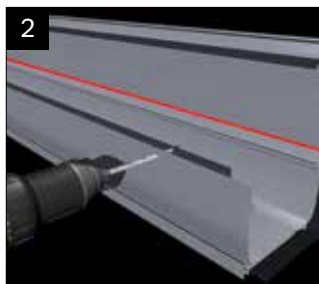

Lift the box gutter down to the ground and turn it around. Drill through the aluminium leg (that abuts the host wall) at the pre-marked positions. Whilst the box gutter is on the ground, seal along the front/rear face where the deep skirt sits inside the head of the extruded box gutter. (Highlighted in red)



Lift the box gutter back into position, check levels, and then mark the wall (through the pre-drilled holes) ready to drill the host wall and grind out for the flashing.



Remove the box gutter and drill the host wall where marked. Grind out the course which is at least one course higher than the raised back height.

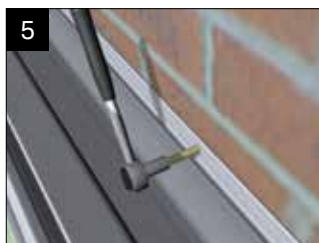

Offer the box gutter into position and insert the anchor fixings that are appropriate for the substrate and tighten up.



Seal the top and bottom edges of the box gutter and follow all other steps as per standard box gutters on page 20-23. When installing the lead flashing, ensure that the top of the flashing is higher than the point of rain water discharge from the glazing bars. Clad off the deep skirt of the raised back box gutter using multi-board (not supplied).

REINFORCED BOX GUTTER INSTALLATION

(USE IN CONJUNCTION WITH STANDARD GUTTER INSTALLATION STEPS)

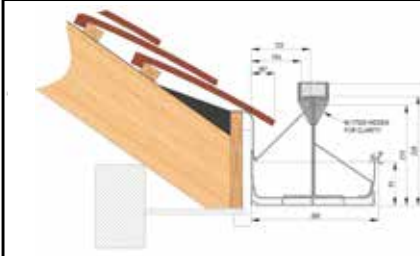

PRE-CHECKS / ADVICE

Box gutter weight is approximately 13kg/m. A 6m box gutter will weigh approximately 78kg. You may consider using lift equipment such as a genie lift or similar.

If fixing to a bungalow soffit, we recommend checking behind the fascia to ensure that there is a suitable substrate to fix to.

Check the roof tile overhang (minimum of 50mm) to ensure it will not foul on the gutter reinforcement. If so either pack off (affecting the roof size) or reduce tile overhang.

SUPPORTS



When using the reinforced box gutter, it MUST be supported at each end by either hup walling, a brick pier, or a post (by 100mm minimum). When the overall length is greater than 6m and a split is required, the box gutter MUST be supported by at least 100mm either side of the joint.

If you would like to use a post as a support, please contact Ultraframe.



Lift the box gutter into position, taking into consideration the weight.

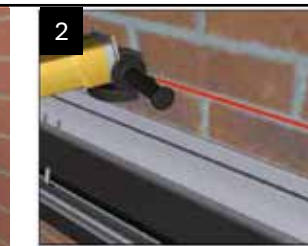

Whilst still supported, pull gutter away from the wall for access and grind a channel in the masonry for flashing. Blow out any dust in the channel.

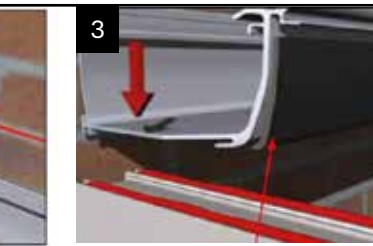

Lift gutter slightly to cut back foam insulation to enable the box gutter to sit flush on the supports.

Apply a continuous bead of appropriate sealant to the front and inner of the supports. Lower the insulated box gutter into position – ensure it has adequate support whilst fitting.



If required, place eaves beam section – with under gutter trim attached onto the side frames. Seal the joint between the eaves beam and box gutter.



Ensuring the box gutter is level, fix back into the host wall through each gap in the I-beam and at both ends of the gutter using appropriate anchor fixings for the substrate. Dependant on access, a socket wrench may be used to reach behind the reinforcement.

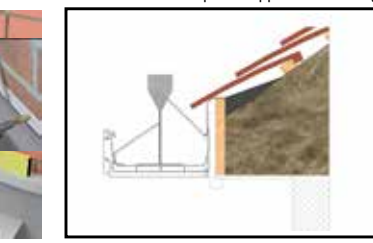

If fitting to a bungalow soffit, ensure that box gutter is fixed along its length into a suitable timber batten behind fascia board using appropriate fixings. When installing a box gutter on a soffit, ensure the soffit is insulated to avoid condensation

SECTION 6 VALLEY INSTALLATION

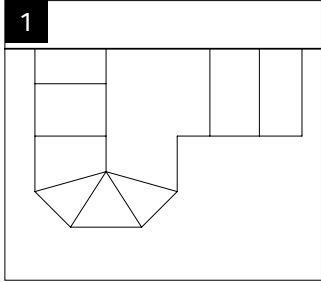

At the stage where all other bars have been fitted and secured to the roof and the ridge and half ridge have been fixed to the wall, the valley assembly should be fitted.



Ensure the two ridges are at the correct height and are level. Make sure bolts at the ridge and eaves have been fitted to accept the valley.



Offer up the aluminium valley section, ensuring the under cladding location bars are slid into position. Locate onto the captivated bolts in the ridge, half ridge and eaves beam. Secure the valley using the 4 spigot nuts provided in the valley end cap kit.

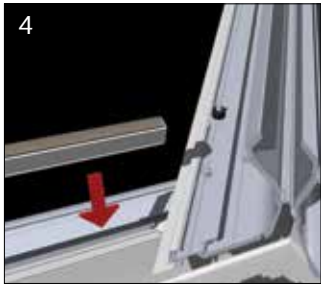

Cut and re-fit the glazing support trim, where the valley meets the eaves beam.

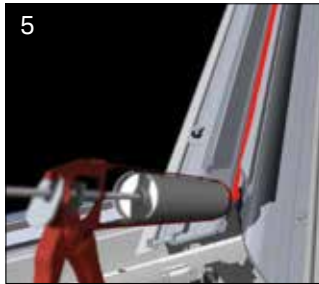

Now run a continuous bead of suitable silicone down the entire length of the aluminium valley profile, at the point of the hinged connector in the centre.

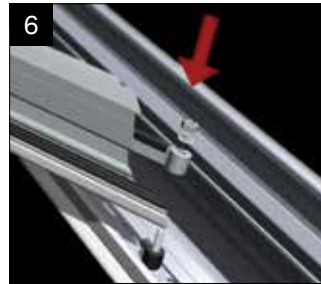

Using the location plan provided, assemble the various valley rafters onto the valley. Use the washers and nuts provided to ensure a robust joint is created.

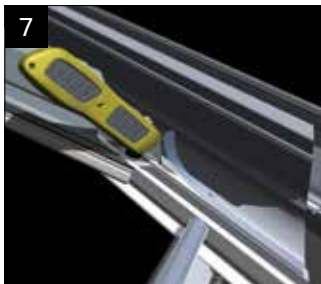

Fit the double sided sealing tape to each of the valley wings. Tease one end of the protective tape loose, crease it about 50mm from the end and fold over ready to extract once the glazing panels are laid in position.



To retain the glazing to the valley wing, fit 2 wire clips (100mm from each end of the profile). The hooks locate behind the lip detail as shown. Apply a continuous bead of sealant (MS Polymer to self cleaning glass).

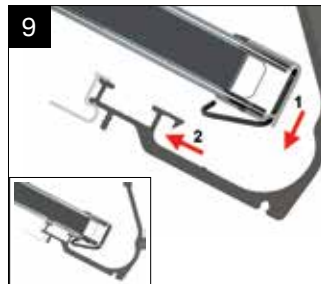

Place the glazing in its correct position. Position the end profile down into the valley as shown. With the glazing pressed flat against the valley profile and your fingers underneath, pull the glazing up into the rain baffle and allow the clip to 'lock' the glazing in place. Once properly fitted, the clip should lock into place as shown.

SECTION 6 VALLEY INSTALLATION

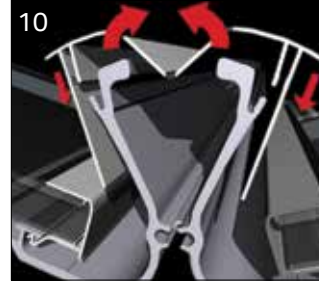

Fit the valley top cladding by folding to form an internal 'V' - then tap into the aluminium valley profile using a plastic hammer.

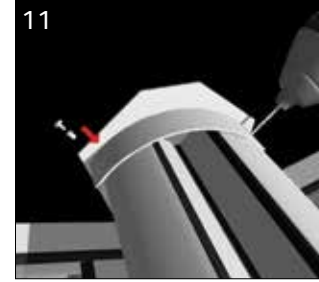

Fit the valley end cap using the two plastic rivets supplied or appropriate fixings.

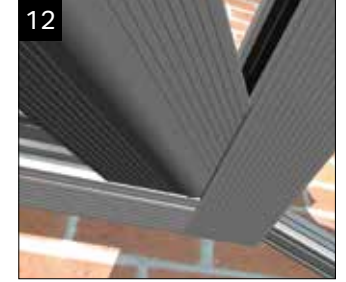

Finally fit the valley under claddings, these may require scribing to suit.

SECTION 7

LEAN-TO INSTALLATION

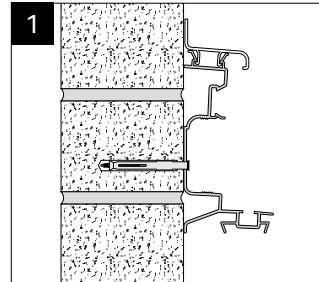

Fix the ridge at the specified height to the wall, drill through the v groove behind the glazing pocket.
If the wall is uneven, packing may be required behind the half ridge.



Ensure all the captivated bolts have been fitted, glazing pocket and ridge fascia. Offer up and secure the rafters on the bolts at the eaves and ridge. Secure with flanged M6 nuts.

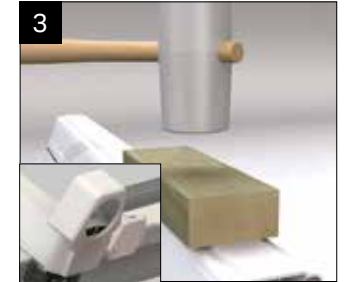

Now glaze the roof, fit the rafter top cappings and the rafter end caps.



Fit lean to ridge top and bottom caps.

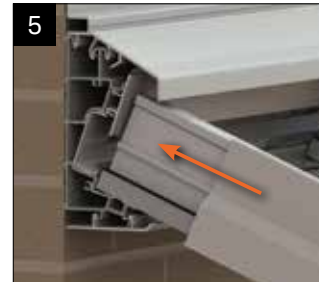

Apply silicone to the gable side cappings and fit to the gable bars. These may require cutting in for a low pitch ridge.

TIP: Screw the side capping to the gable bar at the top and bottom where the screw will be covered by the end caps.



Apply silicone to the inside of the ridge end cap where it contacts the ridge top cap and the gable side capping.

Ensure the lead is flashed over the ridge end caps.

SECTION 8 GABLE INSTALLATION

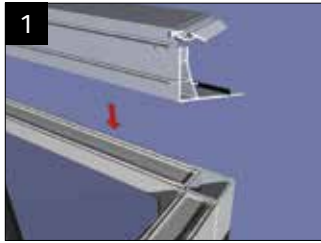

1 Trial fit the gable beam and the eaves beam ensuring the inside face is flush with the inside face of the window/door frames. Remove, then apply a continuous bead of silicone to both the front and rear edges of the window/door frames.

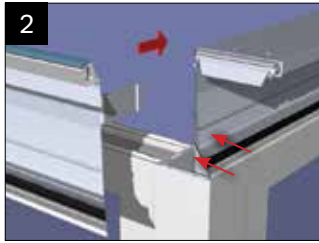

2 Fit the under gutter trim to each section of eaves beam and gable beam, position the beams and slide the corner cleats (already attached to the eaves beam) into the gable beam. Drill through the holes already in the gable beam into the cleats and secure with the screws supplied.

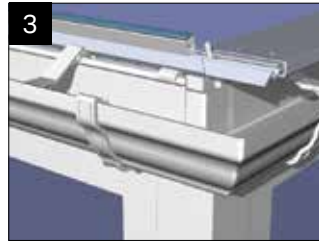

3 To secure the gable beam (see Vic Fixing Kit page 8), then at this stage the guttering is installed. First attach the gutter brackets to the gable/eaves beam. Fit the 90 degree external gutter corners to the gable beam length of gutter. The brackets are at maximum 750mm centres and 200mm from each corner.

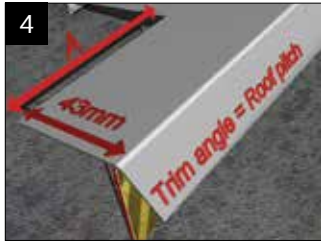

4 With the guttering in place, trim the gable beam top cladding. The cladding is supplied over length and cut to suit the roof pitch (see table).

Roof Pitch (%)	Dim A (mm)
10	83
15	85
20	87
25	89
30	93
35	98
40	104

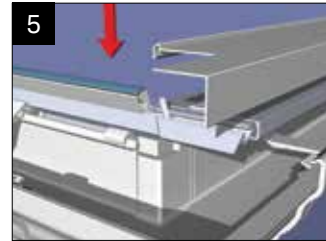

5 Next attach the notched gable beam top cladding on to the head of the gable beam.

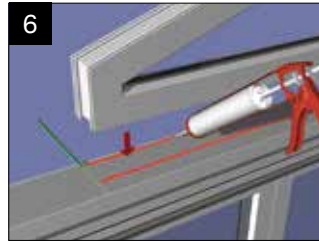

6 Position the gable window frame central to the gable beam, and mark the position. Remove the frame and again run two beads of silicone along the head of the gable beam top cladding (the width of the window frame only). Replace the frame centrally and back against the upstand of the gable beam top cladding. Fix securely through the frame into the head of the gable beam with self tapping screws (not supplied).

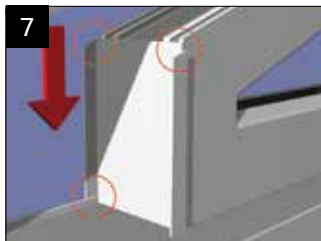

7 Mark and cut the gable infill end cap. Notch inner bottom edge to allow the end cap to sit flush and tight to the gable window frame. Trim top edge to suit pitch of roof and gable frame fitting top cap which should be placed into position for marketing purposes.

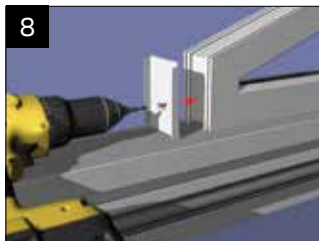

8 First silicone and then screw the end cap to the gable frame.

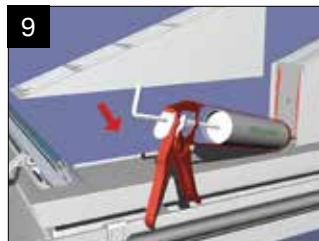

9 Trial fit the gable infill wedge. Remove, run two beads of silicone and place back in position, tight up against the infill wedge end cap.
NOTE: it will be necessary for non standard pitches to trim the infill wedge to suit the pitch, maintaining the 135mm height dimensions.

SECTION 8 GABLE INSTALLATION

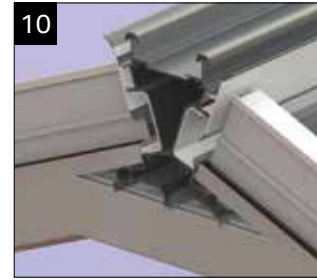

10 Place and support the ridge ensuring the ridge is central to the gable frame. Place the starter bar onto the frame and secure to the ridge and eaves beam. Securely fix the starter bars to the gable window frame. Fit and glaze the roof in the normal manner. **NOTE: Ensure the gable frame is vertically plumb.**



11 Offer up the gable side cappings, insert these onto the hooks on the gable bar. Scribe at the eaves end against the gable beam top capping. **Fit the ridge top cap if not done so already.**

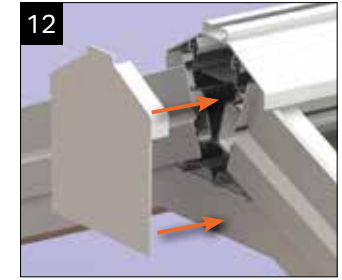

12 Apply silicone to the inside of the ridge end cap where it contacts the ridge top cap and the gable side capping.

SECTION 9 HIP LEAN-TO INSTALLATION



1 Follow the lean to installation steps on P19. Ensure the half spider has been fitted as well glazing fascia which should extend 70mm past the end of the ridge at the spider.



2 Once all rafters have been fitted to the ridge, fix the starter bar, with the spider arm attached, to the wall whilst secured at the eaves and spider.



3 Then fix any other hips that may be present and secure to the spider and at the eaves.



4 Offer up the half internal crown cap so that the skirt touches the bottom of the rafters. When in position screw to the host wall

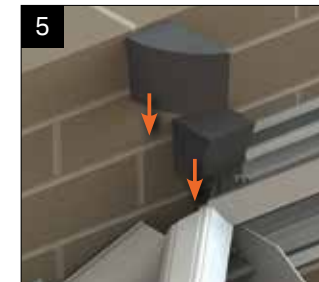

5 Once the roof has been glazed and the glazing bar top caps have been fitted, insert the foam at the crown point. Fit the ridge top and bottom caps. (Cut the foam to suit the situation).

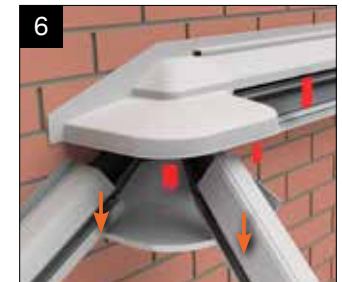

6 The half ridge crown cover will be factory fitted to the ridge capping. Position and fit as one assembly.

SECTION 10
CONSERVAFLASH



At this stage it is easiest to mark and cut out for the lead flashing. For best results always grind a 35mm deep slot to allow Conservaflash to be let into the wall. Brush out any dust from the channel.

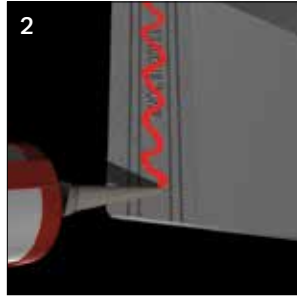

Trial fit the stepped flashing. Start installing from the gutter towards the ridge. Apply sealant (clear or grey low modulus neutral cure) along the two internal weather bar grooves.



Place Conservaflash into the ground out mortar joint at the gutter end, ensuring lower edge locates into the 'J' soaker.



The unique integral mechanical retention wedge clips bite into the brickwork ensuring positive location. Insert the next stepped flashing (using sealant on the back), ensuring it overlaps to marked minimum. Continue up the roof, both slopes, with stepped flashings.

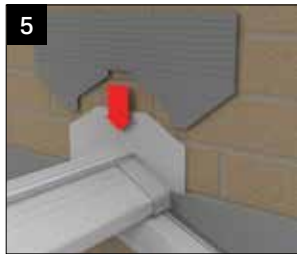

Having added last stepped flashings each side of the ridge 'Butter' the reverse side of the saddle trim and place over the ridge body.

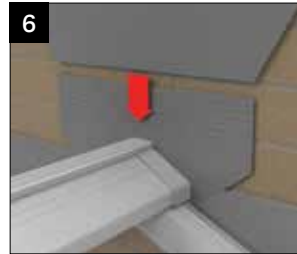

Offer up the horizontal flashing which should typically sit two courses above the stepped flashing. Trim to suit the roof pitch.

Use appropriate sealant, MS polymer if self cleaning glass. Always seal the surface of lead flashing to prevent run off onto self cleaning glass.

SECTION 11
MUNTIN BAR INSTALLATION



IF YOUR SEALED UNITS HAVE BEEN SUPPLIED WITH TAPED EDGES, ALWAYS REMOVE THE TAPE PRIOR TO INSTALLATION. Take the muntin bar profile (top and bottom section) that matches its corresponding sealed unit. Take the lower section and allow it to span between the two adjacent glazing bars. Lower into position the up slope sealed unit. NOTE: MUNTIN SHOULD BE SAME WIDTH AS UNIT.



Now take the upper section and lay it face down onto a smooth clean surface. Using the relevant sealant (MS Polymer sealant such as Rotabond 2000 must be used on self cleaning glass), apply a generous bead to each side, immediately behind the gasket.

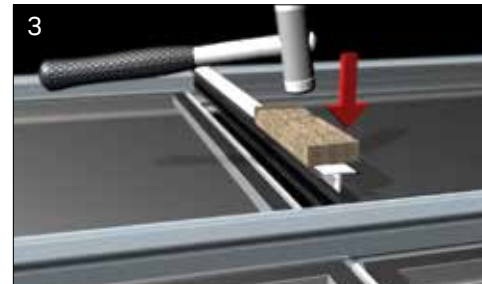

Now lift the sealed unit that goes on the lower slope into position, turn the upper profile over, place it into position and tap down the profile using a non marking plastic mallet. Wipe clean any sealant from the unit face. NOTE: WE RECOMMEND A SECOND PERSON TO SUPPORT THE MUNTIN FROM THE UNDERSIDE WHEN TAPPING DOWN.



Now, tap the PVCu top cap into position, which will 'trap' the muntin profiles.

CAPPING REMOVAL



Insert the capping removal tool as shown.

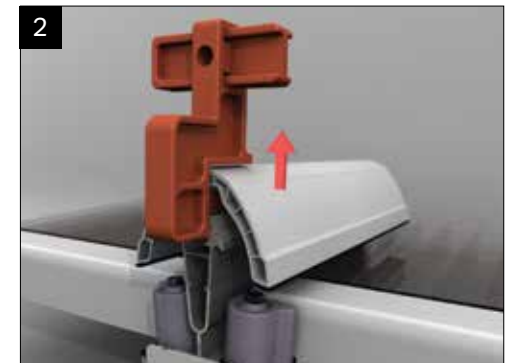

Lift the capping removal tool up, releasing the top cap legs from the aluminium.

GUTTER COVER INSTALLATION

Ensure the eaves beam, glazing bars, ridge/wallplate are already installed
 Ensure the eaves beam, glazing bars, ridge/wallplate are already installed



1
Decide the position of the gutter outlet. Using a 68mm dia hole saw, cut the hole for the down pipe in the lower section.

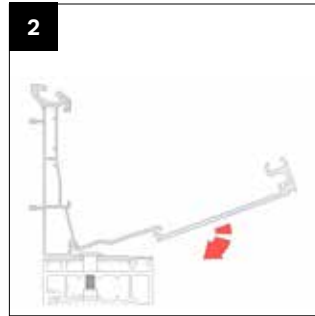
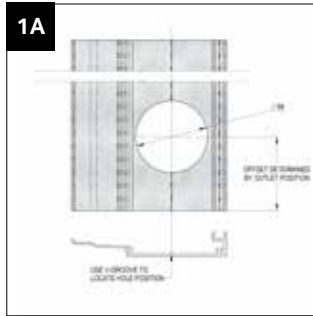

2
Remove the under gutter trim and dispose of it. Hook the lower cornice section under the extended leg on the eaves beam. Then rotate the cornice profile so it sits flat. Please note: always start with the front facet.

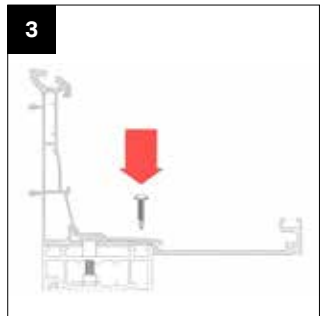

3
After rotating the lower cornice profile secure it in place using a FSD-42-19 fixing along the V-groove at both ends.



4
Fit the cleats (CRN001) to the desired side using the fixings provided (CRN006) as shown and assemble the remaining lower sections.



5
Secure each corner using the cleats (CRN001) and fixings provided (CRN006). The gutter and glazing should now be fitted (see main guide). Check integrity of all gutter joints before proceeding further.



6
Place the support bracket on top of the gutter and slide it along up to the gutter bracket. Then push it into the gutter bracket until they're aligned.



7
Take the middle cornice section and lower it into the lower cornice and support bracket.



8
Offer up the middle Cornice section into position, secure using fixings provided FSD-42-19. (Long reach driver required).

GUTTER COVER INSTALLATION

Ensure the eaves beam, glazing bars, ridge/wallplate are already installed



9
Fit cleats as shown in step 4. Offer up the next middle Cornice section. Secure corners using the cleats (CRN001) and fixings provided (CRN006).

ADDITIONAL STEPS - WHEN CORNICE IS USED WITH LOGGIA COLUMNS

Ensure the eaves beam, glazing bars, ridge/wallplate are already installed

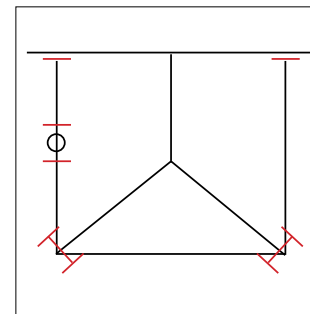

'H' or '-' shows position of DAMS.

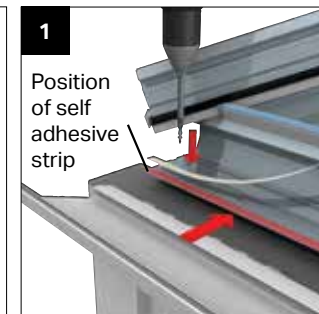

1
Remove under gutter trim, attach self adhesive strip to 'toe' of eaves beam.



2
Silicone seal front and back edge of lower Cornice sections (be generous). Similarly butter 'DAM' sealer - position within 50mm of any stop end or outlet.



3
Take 'rubberized' sealer strips and generously butter with silicone.



4
At 90° corner insert 'H' section and press down. Similarly apply at stop end or outlet positions.

1 tier Cornice
GO TO PAGE 9

For 2 tier Cornice
GO TO PAGE 12

For 3 tier Cornice
GO TO PAGE 16

For curved Cornice
GO TO PAGE 6

GUTTER COVER INSTALLATION - TOP SECTION

Ensure the eaves beam, glazing bars, ridge/wallplate are already installed



1
Temporarily support and fit the upper Cornice section, using the fixings provided (FSD-42-19).

2
Secure the corners using the cleat (CRN001) and fixings (CRN006).

3
Secure the upper Cornice section using the wire ties at each glazing bar. Hook the wire tie into the pre-drilled hole in the upper Cornice section and screw fix into the glazing bar, ensuring the upper section remains parallel to the frames/roof line.

CURVED CORNICE INSTALLATION - CORNER SECTIONS

<p>90° Corner (no columns) CRN090</p> <p>90° Corner (small columns) LRP022</p> <p>90° Corner (large columns) LRP021</p> <p>135° Corner (no columns) CRN135</p>	<p>Long Corner Wire Tie CRN012</p> <p>← 275mm →</p>
<p>Fixing Screw CRN010 (Wire tie to hip bar)</p>	<p>Fixing Screw CRN007 (2 per corner)</p>

Please note that it is not compulsory to fit the corners. If a crisp sharp mitre is required the corners need not be fitted, provided due care has been taken during installation. If on the other hand the 'look' of the cast corner is preferred follow the instructions above for each relevant corner. Corners will be supplied for the 135° & 90° external corners.



1
Prior to fitting the corner insert the special longer wire tie CRN012, into the corner as indicated

2
Whilst ensuring that the corner remains located in position, screw fix using self drilling screws CRN007

3
Finally secure the corner by screw fixing the wire tie to the glazing bar using self drilling screw CRN010

GUTTER COVER INSTALLATION - JOINTER SECTIONS

<p>Cornice Straight Jointer CRN180</p>	<p>Cleat Fixing Screw CRN006 (2 per jointer)</p>	<p>Cleat CRN001</p>
	<p>Fixing Screw CRN007 (2 per jointer)</p>	

Please note that it is not compulsory to fit the jointers provided. If due care has been taken with the installation of the Cornice. If on the other hand the 'look' of the cast jointer is preferred follow the instructions above for each relevant jointer. Some companies MAY have ordered a 'dummy' joint at 'mid-run', if so just follow steps 2 + 3. The die cast straight jointer can also be configured on site to be used at host wall position.

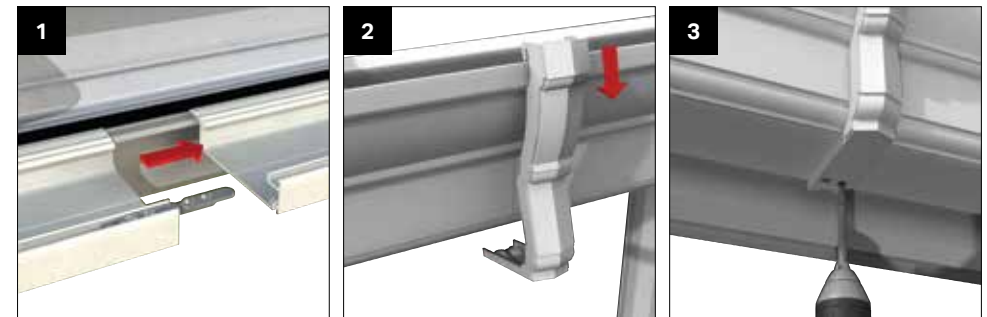

1
Attach the cleat CRN001 using 2 x CRN006 provided, on each side of the joint. Repeat for each of the Cornice 'layers'.

2
Offer up the CRN180 straight jointer, hook over the front lip of the Cornice

3
Whilst ensuring that the inline bracket remains located in position, screw fix using self drilling screws CRN007

CURVED CORNICE INSTALLATION - ADDITIONAL DETAILS













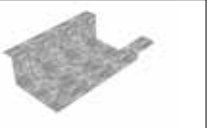











When there is a cornice return, complete step 1A in the general installation. Then pre-drill the cornice return profiles at approximately 300mm centres along the v-groove. Align the lower return profile with the adjacent cornice, push the profile up to the brick and mark the holes. Remove the profile then drill into the brick and plug, align the profile with the drilled holes and fix in place.

Take the gutter bracket channel profile and lower it until it sits on top of the cornice return profile. Once in position complete the same process as in step 1A, fixing into the central v-groove.

GUTTER STOP END DETAIL - Used with lean-to roofs, gable roofs or when then gutter returns along the host wall. Secure the end plate into position using the fixings provided (CRN008).

COMPONENT PARTS LIST

 CHA405/1 Perimeter Channel - PIERCED	 CHA405/2 Perimeter Channel	 CHA405/3 Crossrail Channel	 Bolster Corner Infill
 CHAB001 Transom Bracket	 CHAB090 Georgian Hip Bracket	 CHAB003 Hip Bracket Adjustable	 CHAB011 Splay Bar Bracket Assemble
 CHAB013 Closure Trim Support Bracket LH (Bolster)	 CHA009 Bolster Transom Bracket	 CHA010 Bolster Hip Bracket Assembly	 CHA012 Bolster Splay Bar Bracket
 CHAA006 BAG OF 25 - M4 x 13 Self Drill Phillips Wafer Head	 CHA007 BAG OF 25 - 4.2 x 19 Self Drill Phillips Head Screw	 CHA008 BAG OF 25 - 4.8 x 32 Self Drill Phillips Pan Head	 CHA002 Poly Panel Spring Clip
 CHA015 Super Duty Eaves Poly Support Clip	 CHA200/7 Vent Foam	 LUVGS & PST Top Cavity Closing Trim & Sealing Foam	 CHA300/GR/4 1.25mm Plaster Stop Edge Bead - Painted
 CHAA165 or CHAA265 Gallows Packer 165 or 265	 CHA005 Single Tie Bar Cover		

POLY, LUVGS & PST OFFSETS

Bolster Offsets

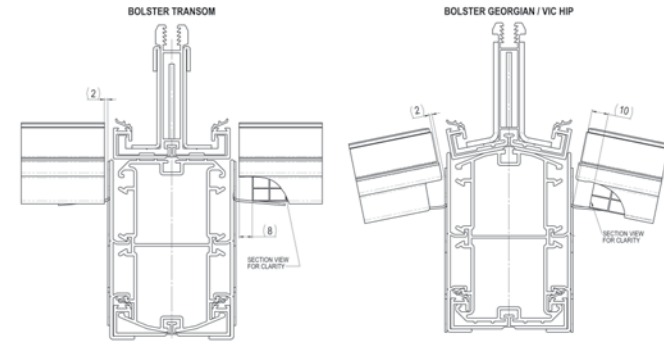

Hip Bar Offsets

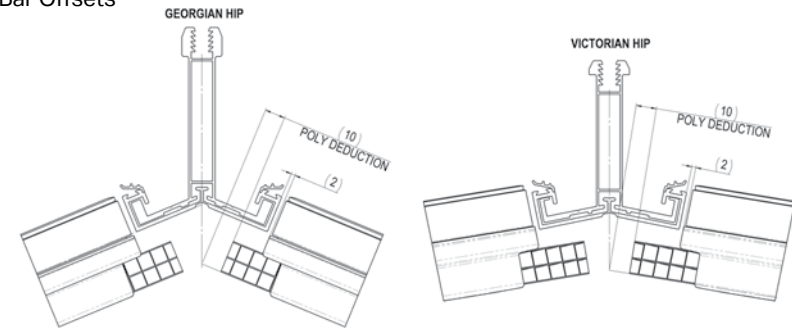

Starter+Gable Bar Offsets

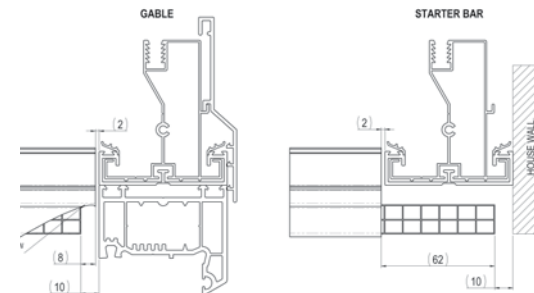

Transom Bar Offsets

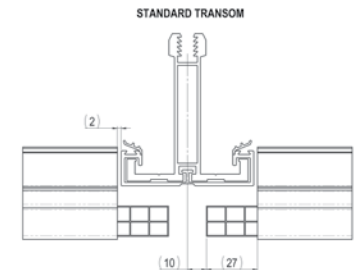

Should you find damaged or missing components, please always reference replacements with both a parts code (see above) and/or its position on the location plan. This will help with the speedy resolution of any issues.

Packer / Spacer slips over



Finished installation you need to find

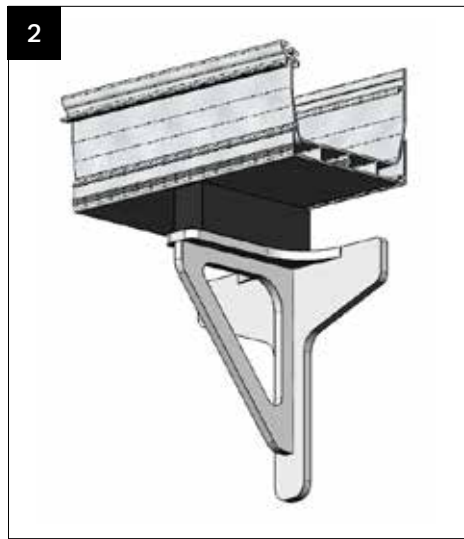

On an installation of roof and internal insulated pelmet you MUST have this situation when you arrive on site. Structurally, it is not permissible to insert this packer / spacer when the roof is already glazed.

Box Gutter - 165mm

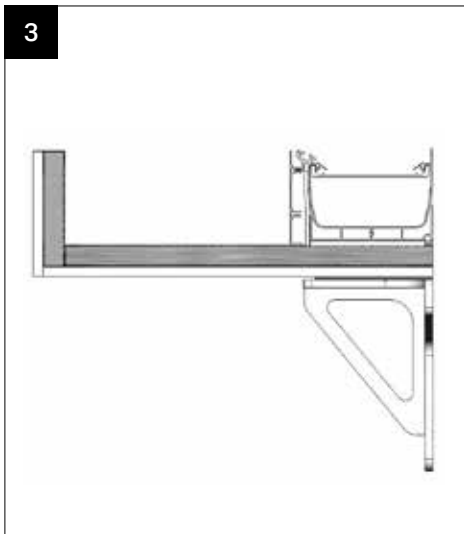

Box Gutter - 265mm

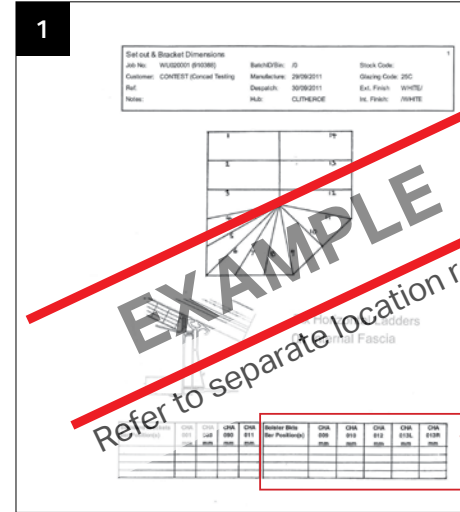
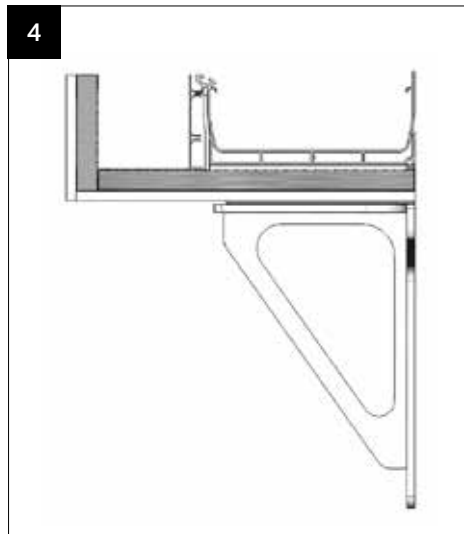

The internal insulated pelmet component location plan is packed in the component box.

The location plan indicates bracket measurement / position and component positions.

EXAMPLE
Refer to separate location report

Bolster bar set outs - see page 20

INSTALLATION SEQUENCE

Additional notes if Bolsters fitted*

- A** FIT VENTILATION FOAM
- B** FIT BRACKETS
- C** FIT POLYCARBONATE CLOAKING SCREEN CLIPS TO FASCIA
- D** FIT TOGETHER POLYCARBONATE AND GLAZING SUPPORT CARRIERS
- E** FIT SUPPORT CARRIER AND POLYCARBONATE BETWEEN BRACKETS
- F** FIT HORIZONTAL LADDER & TEMP SUPPORT
- G** FIT VERTICAL LADDERS
- H** FIT PLASTERSTOP EDGE BEAD

N.B NOT GEORGIAN IF BOLSTERED*

N.B N.B FIT CORNER LADDER INFILLS IF BOLSTERED*

INSTALLATION - VENTILATION



FITTERS TIPS - Some consider it good practice to silicone seal round ends of support trim

When the roof and internal insulated pelmet are ordered together, this ventilated glazing support trim arrives with breather foam already inserted into the cavity to prevent insect ingress.

If internal insulated pelmet is being installed into an existing older roof, it is important that the steps to the right and below are followed.

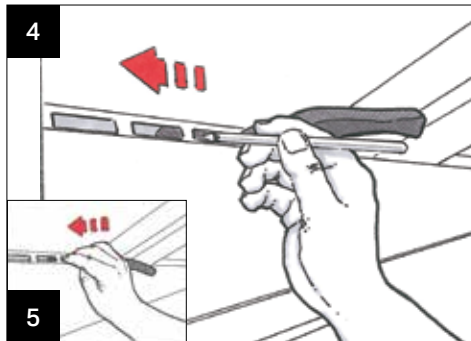

If the existing roof already has Eavesflow ventilators fitted, unclip and dispose of the ventilators and then introduce the foam strip using a pencil and thread along until all the slots have the foam behind.

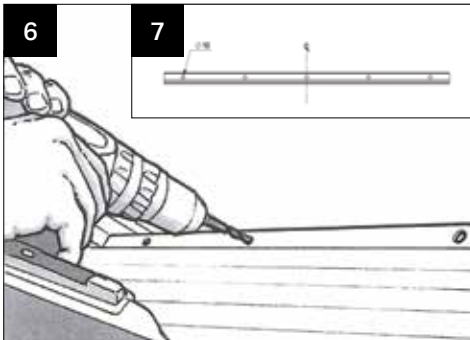

If the existing roof doesn't have Eavesflow fitted, then take a 10mm drill and drill through the glazing support trim from inside to outside to create 5 holes per 'bay' - ensure this is done over the length of 250mm, centred in the middle of the glazing panel.

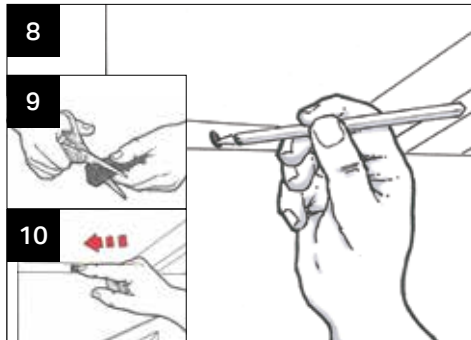

Now, cut the foam strip into 25mm pieces and insert into each hole, ensuring it sits comfortably and unobtrusively into each hole.

INSTALLATION - BRACKETS

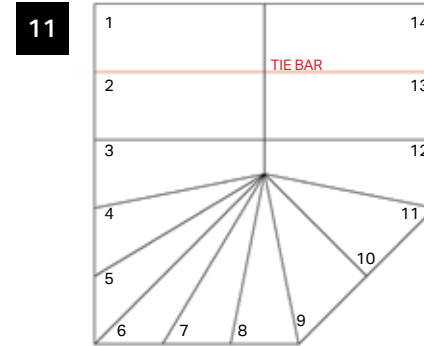

12

ROOF POSITION	STANDARD BAR BRACKETS POSITION (mm)			
	CHA001	CHA003	CHA090	CHA011
1, 2, 3, 12, 13, 14	200			
4, 5				389
6			382L/389R	
7, 8				384
10	384		384L/389R	
11			384R	

IMPORTANT NOTE: Left (L) and right (R) dimensions are viewed internally.



Measurements are ALWAYS from the top edge of the PFTC fascia board

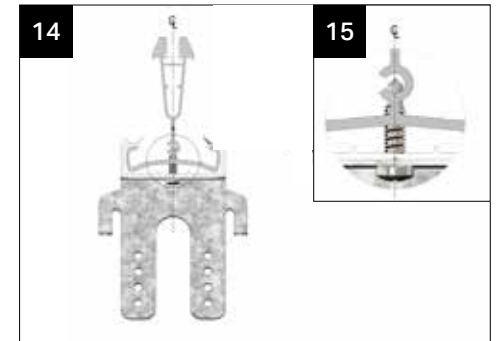

NOTE: Bracket fixing screws must be fit central of glazing bar, mark up the centre line of the bar on to the undercladding if it is not clear by sight.

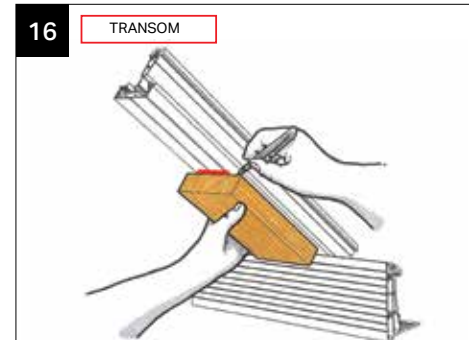

Using the location plan provided - see example above - find the dimension for setting out clip positions on the transom bars. Measure up the bar from top edge of fascia board, and mark it (see 13 above). If your roof features many transom bars, it may be simpler to cut a piece of timber to length and use as a template.

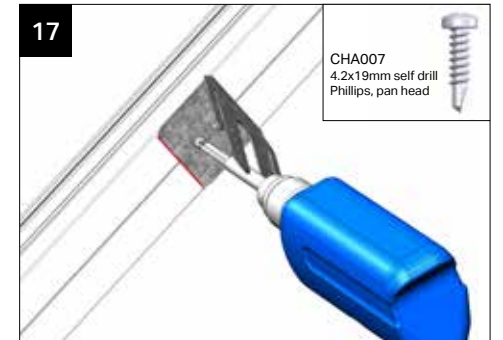

Take the transom bracket (CHA001) and attach using two 4.2 x 19mm self-drill Phillips pan head screws supplied - the back edge of the bracket should butt up to the pencil line.

INSTALLATION - BRACKETS

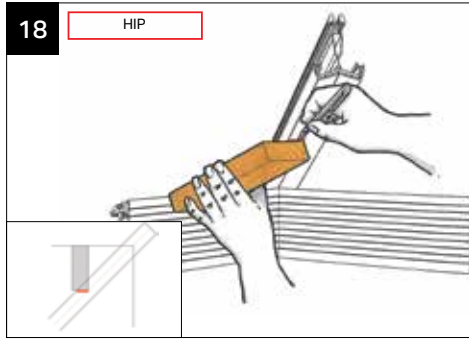

Similar to step 16, seek the set out dimension from the location plan (12) for the Georgian or Victorian bar. Mark with a pencil line. Please note the dimension will be different from the transom bar. This graphic shows the left hand dimension being marked. Timber template to be held square to fascia board.

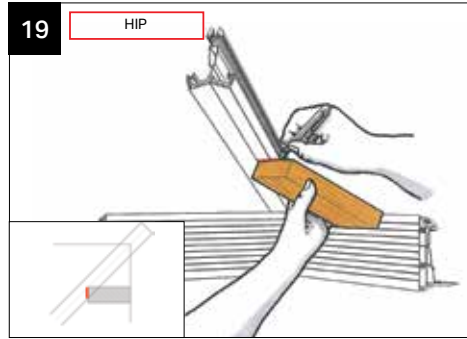

From the location plan, now mark the right hand fixing position.

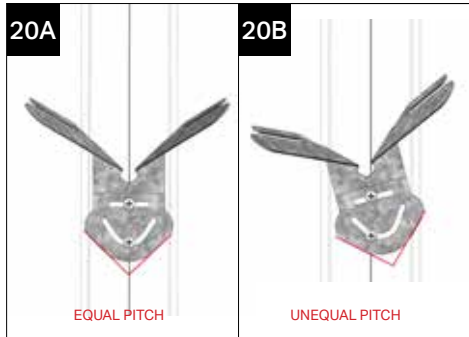

Now offer up the Georgian hip bracket (CHAB090) – where the roof is equal pitch across the hip, the bracket should sit as (a). On unequal pitches, the bracket may be skewed as in (b).

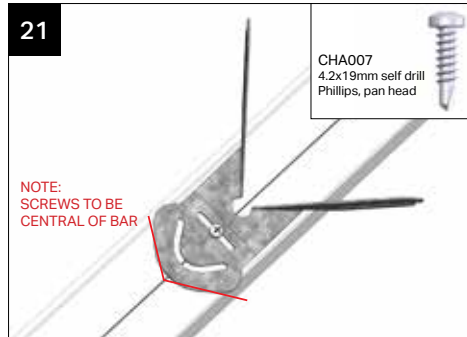

Now attach using one of the two 4.2 x 19mm self drill Phillips pan head screws supplied – one screw curved top slot – do not 'nip up' at this stage, but allow bracket to pivot.

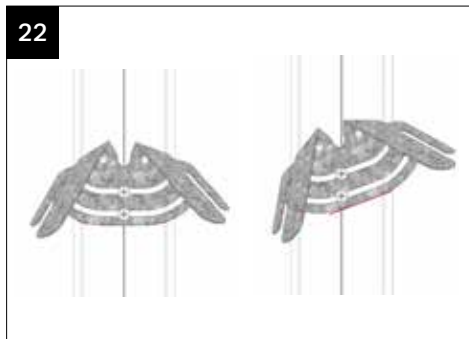

If the roof layout has an angle other than 90 – 9 and 1 on the sample location plan, a CHAB003 adjustable hip bracket should be used. On unequal pitches, the bracket may be skewed as in (b). Attach using one of the two 4.2 x 19mm self-drill Phillips pan head screws supplied – in top slot – to allow bracket to pivot.

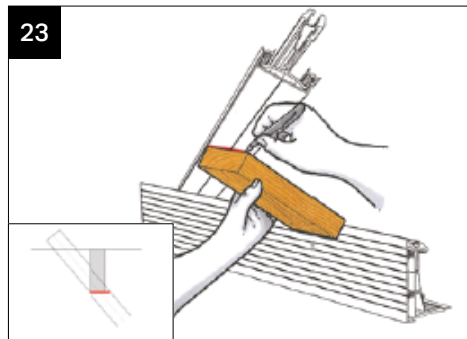

On a splayed bar – 7 and 8 on the sample location plan – measure and then strike a line across the face of the splayed bar's undercladding. Timber template to be held square to fascia board.

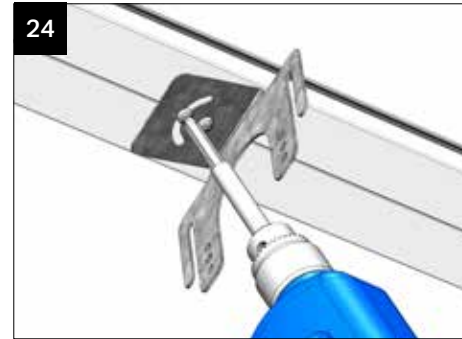

Now attach bracket CHAB011 using one 4 x 19mm self-drill Phillips pan head screw – ensure screw in curved slot is in centre line of bar.

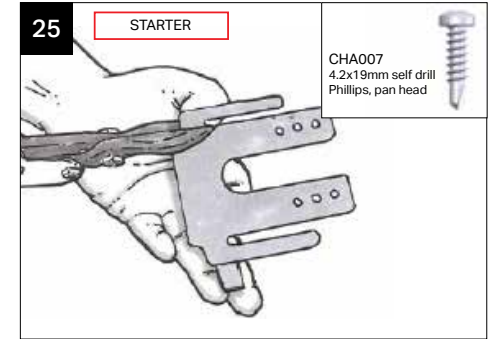

On the starter bar, take a CHAB001 Transom bracket and snip off the long leg tab – if the wall is already plastered, further trimming maybe required.



Measure, mark and fit the trimmed down starter bracket using two 4.2 x 19mm self drill Phillips pan head screw.

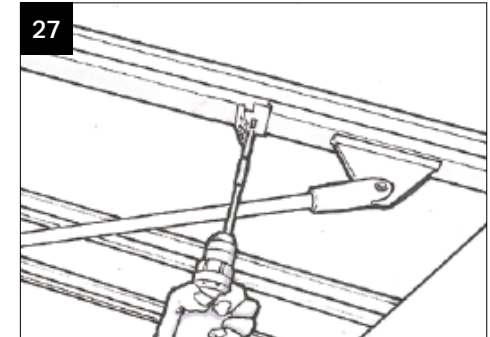

When there is a transom bracket on the same glazing bar as a tie bar, it is suggested that a long driver bit is used to facilitate easy fitment.



Using a long level butted up to the brackets on the transom bars adjacent, strike a line through to locate the final position. Tighten up the one previously fixed screw and add one more 4.2 x 19mm self-drill Phillips pan head screw.

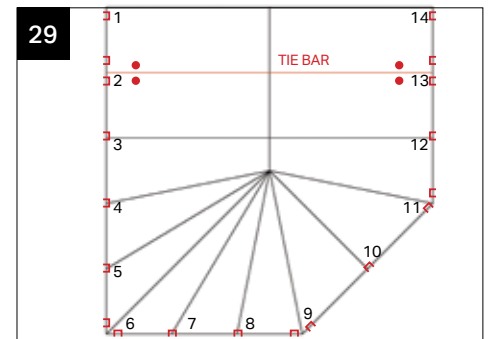

Symbol '□' shows if one support clip is needed central to the bar or one each adjacent to the bar.

INSTALLATION - BRACKETS / CLOAKING PANEL CLIPS

INSTALLATION - CLOAKING PANEL CLIPS

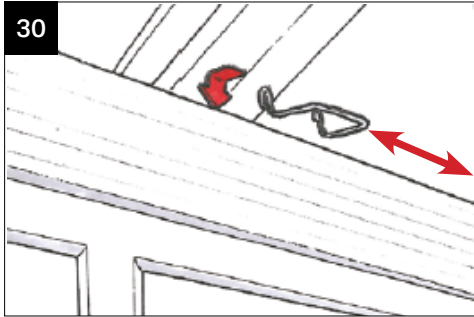

Over the planked fascia board at the eaves, at each transom (but not tie bar locations) and splayed bar position, hook over the cloaking panel support clips CHA002. The brackets can be slid side to side along the eaves fascia board. **FITTERS TIP:** When fitting the modesty poly with the fitted LUVGS profile, it may be easier to slide the bracket to one side to allow more room and then slide back underneath once in position.

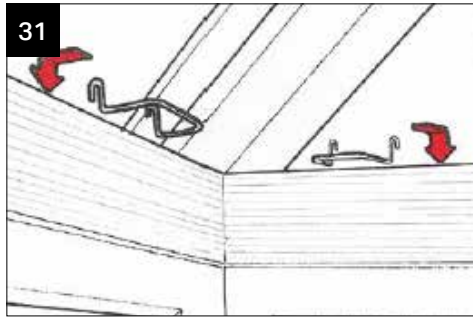

On starter bars, hip bars and transoms with tie bar brackets, a cloaking panel support clip is placed each side of the bar. The brackets can be slid side to side along the eaves fascia board. **FITTERS TIP:** When fitting the modesty poly with the fitted LUVGS profile, it may be easier to slide the bracket to one side to allow more room and then slide back underneath once in position.

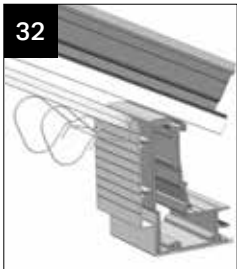

IMPORTANT NOTE: If Super Duty eaves beam is used, then these are the cloaking panel clips (CHA015) that are supplied.

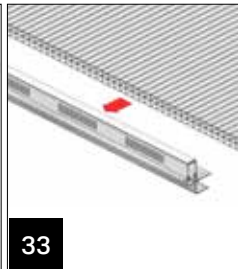

Fit the 16mm polycarbonate sheets to the corresponding LUVGS glazing support carriers, ensuring the polycarbonate flutes are perpendicular to the LUVGS. Refer to poly, LUVGS and PST offsets for positioning (page 9).

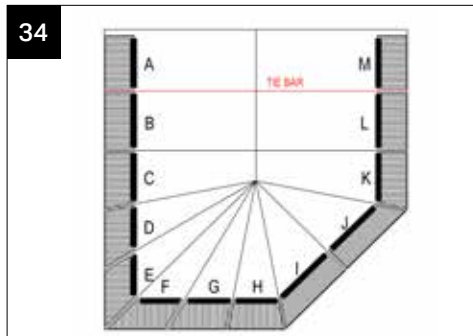

Refer to the location plan for the positions of each polycarbonate-LUVGS assembly.

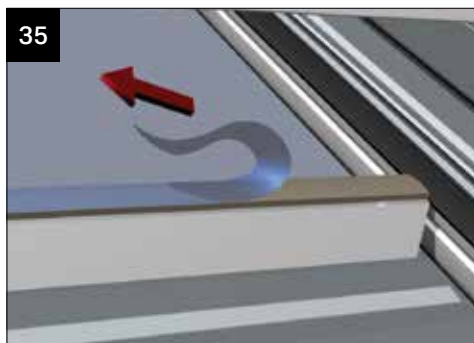

Before placing the polycarbonate-LUVGS assemblies, peel back one end of the glazing support tape protective film (ready to be pulled away when the sealed unit is finally in position).

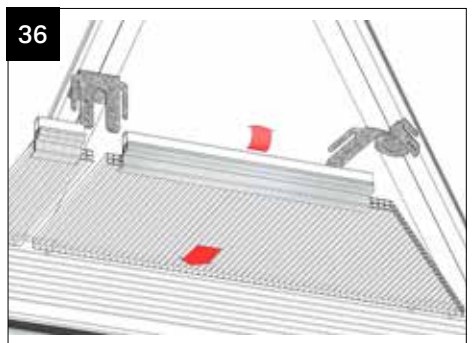

Place each polycarbonate-LUVGS assembly into its corresponding location: Sit the poly end on the support clips that are hooked over the fascia. Then push the LUVGS end up to the bars, resting it on the brackets. (Note: the brackets may need to be bent to allow this). If tight, slide eaves support brackets (step 31) to the side and then return after fitting modesty

INSTALLATION - POLYCARBONATE CLOAKING PANELS

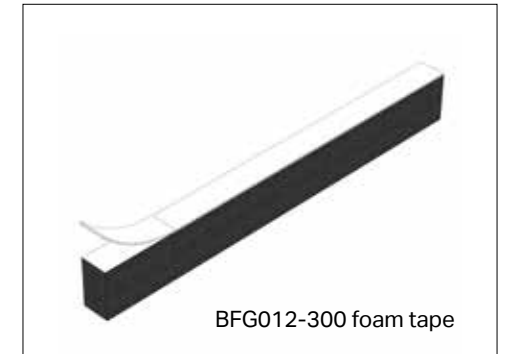
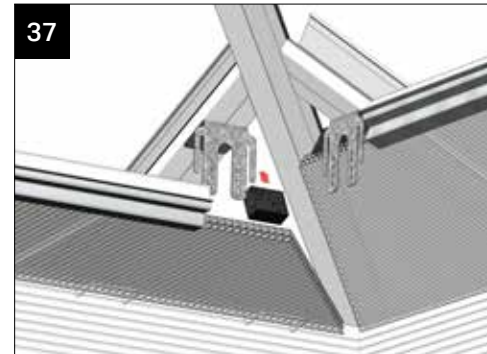

If there is no LUVGS specified at a corner or valley corner due to tight jack rafters, cut a piece of BFG012-300 foam tape to size, remove the protective film and adhere it to the glass. Then fit the polycarbonate.

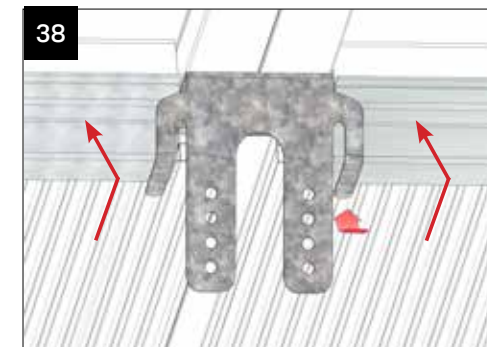

Next bend back the bracket tabs to hold the LUVGS and polycarbonate in its final position. Pull LUVGS profile back against bar brackets and then pull loosened protective tape away from glazing support, pushing against the underside of the glass.

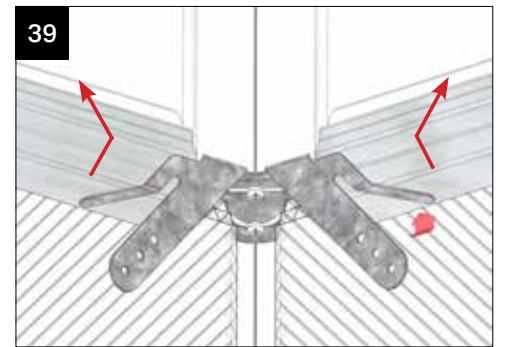

Bend back the tabs on the hip brackets – ensure the LUVGS is secured each side of the hip. Pull LUVGS profile back against bar brackets and then pull loosened protective tape away from glazing support, pushing against the underside of the glass.

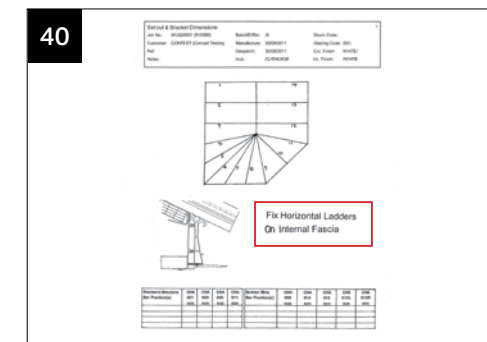

IMPORTANT NOTE: Now check on the 2 page location plan whether the horizontal frame is for 'on fascia' fixing (see 41) or 'below fascia' fixing (see 42).

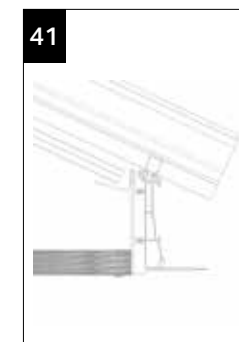

ON FASCIA

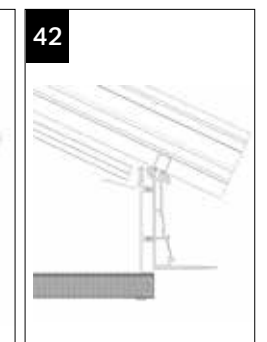

BELOW FASCIA

INSTALLATION - HORIZONTAL LADDERS

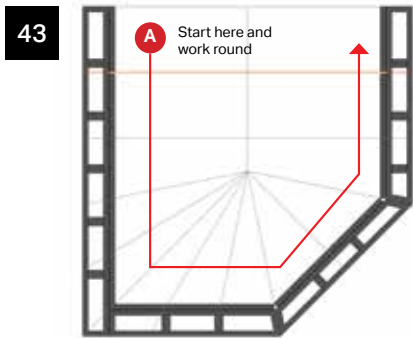

Refer to the location plan and always start from position A.

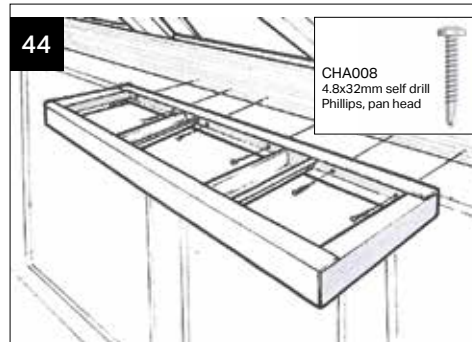

Offer up the first horizontal ladder- An adjustable support prop will help you here. Use two fixings 4.8 x 32mm CHA008 at 250mm centres into pre punched holes to attach the ladder.

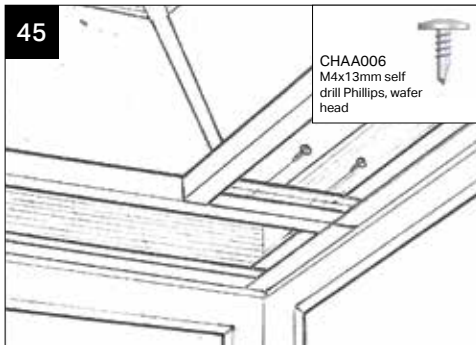

To attach two horizontal ladders at the corner use two fixings M4 x 13mm per butt joint.

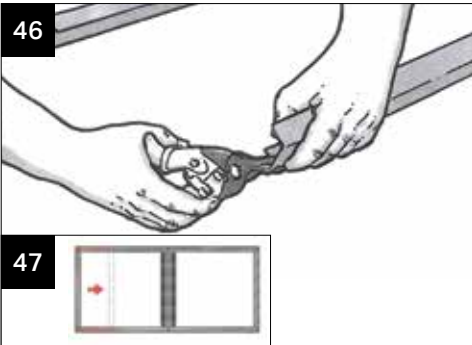

If it is necessary alter length of frames, simply remove end rail, trim with tin snips and reconnect.

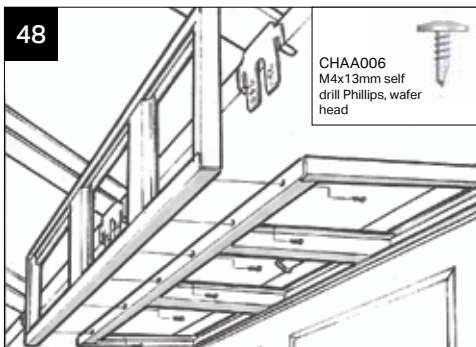

Using the location plan, choose the matching vertical ladder and offer it into position – hold firmly whilst attaching to the matching horizontal ladder using M4 x 13mm fixings, at 250mm centres into pre punched holes. Ensure the vertical ladder is behind the brackets.

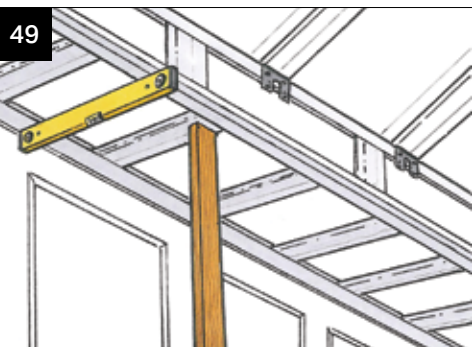

Undertake a final check that all is plumb, level and true.

- All ladders are labelled with the same number as the eaves beam they are attached to (from the location plan),
- Then they have a V or a H depending whether they are a Horizontal or Vertical ladder,
- If the ladder is split into pieces due to the ladder going over length, or being split by bolsters, tie-bars etc then they additionally labelled with an "a", "b", "c", "d", ...

INSTALLATION - HORIZONTAL LADDERS

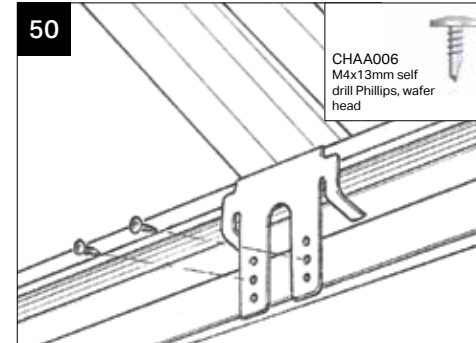

For each transom bracket use two M4 x 13mm fixings – the layout of the ladders should help you choose which of the three fixing positions to choose from.

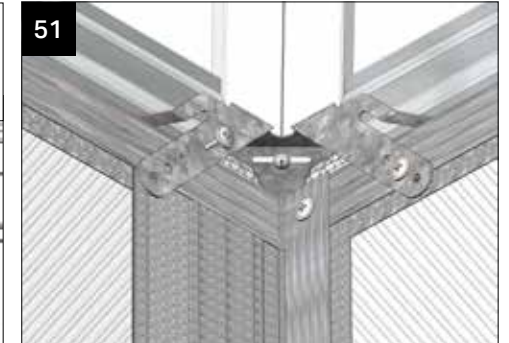

On the Georgian bar, use one fixing per side to fasten the bracket to the vertical ladder – use M4 x 13mm fixings.

INSTALLATION - VERTICAL LADDERS



This is the arrangement around tie bars.

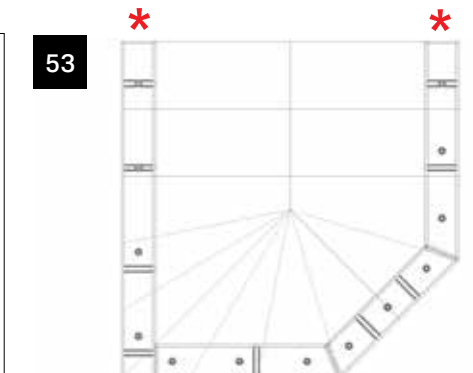

IMPORTANT NOTE: Before applying 12.5mm foil backed plasterboard to ladder framework ensure horizontal and vertical ladders are fixed back to host wall. Finally, check lighting positions and adjust horizontal ladders to suit see step 54.

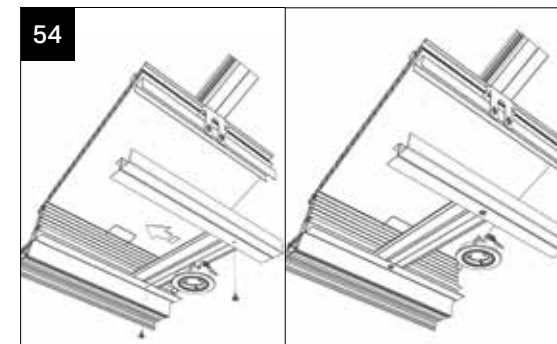

If a spotlight clashes with a cross rail, simply unscrew the cross rail and relocate as close as possible to the original location. Spot light no longer clashes as horizontal ladder is re-configured on site.

All electrical work must be carried out by a qualified electrician and tested in accordance with current BS7671 IEE wiring. Only LED IC (insulation contact) fire rated downlights to be used.

PLASTERBOARDING & PLASTERING

Guidance is based on advice provided by the SITE BOOK available from

www.british-gypsum.com
or call 0844 800 1991
bgtechnical.enquiries@bpb.com

This guidance is based on the use of Thistle Finishing Plaster and 12.5mm Gyproc Wallboard Duplex T/E which has an additional metalised polyester film to act as a vapour control membrane.

- Based on a 2mm skim finish. Temperature must be maintained above 5deg C until plaster is dry.
- Plaster skimming should always commence as soon as possible after the boards are fixed.
- Use thin wall beads attached with 'dabs' of plaster – to provide additional support during drying, attach with non-rusting nails, screws or staples
- Reinforce flat joints with Thistle ProTape 50 or FT100 – these are made from glass fibre and are self adhesive and fitted before plastering.
- Any gaps bigger than 3mm must be pre-filled and reinforced using Gyproc Joint Tape which is embedded in the first coat over each joint, where sufficient plaster is left under the tape to ensure good adhesion and then a second plaster application used. This method is better resistance to cracking than glass fibre tapes.
- Ensure all plasterboards fitted to the horizontal and vertical ladders are scrim taped to the host wall prior to plastering.
- Apply Thistle Finishing Plaster with firm pressure, build out to 2mm thickness in two applications and then trowel to a smooth finish.



Once 12.5mm plasterboard is fitted, the tie bar rose (CHA005) flexes over the PVC conduit and should be spot bonded into position.



Ultraframe supplies a plasterers stop bead (CHA300) for the top edge adjacent to the glazing – ensure it is attached as shown. Be careful when handling/cutting this item not to damage the paint surface.

INSTALLATION - BOLSTER BARS

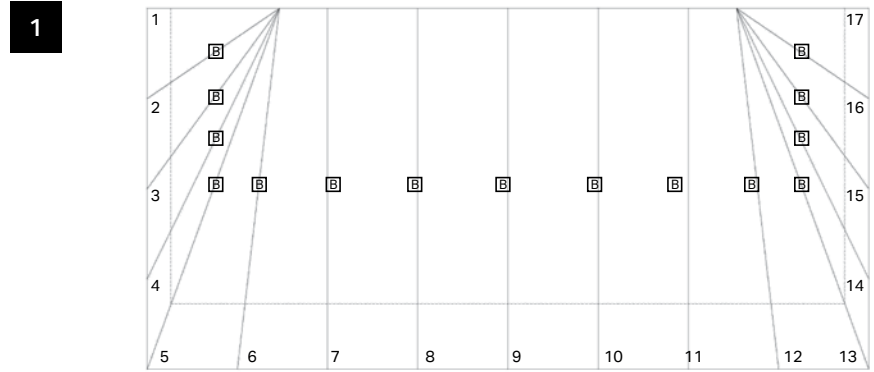

USE THE LOCATION PLAN TO FIND THE BOLSTER BAR LOCATION DETAILS

ROOF POSITION	STANDARD BAR BRACKETS POSITION (mm)				BOLSTER BAR BRACKETS POSITION (mm)				
	CHA001	CHA003	CHA090	CHA011	CHA009	CHA010	CHA012	CHA013L	CHA013R
1, 17	304								
2							228	-1	58
3							219	-4	115
4							216	0	178
5							fit to suit	702	780
6							699	34	-5
7, 8, 9, 10, 11							-26	728	728
12							699	-5	34
13							fit to suit	780	702
14							216	178	0
15							219	115	-4
16							228	58	-1
	TRANS	ADJ HIP	TRANS HIP	SPLAY	TRANS BOTTOM	HIP	SPLAY BOTTOM	LEFT SIDE	RIGHT SIDE

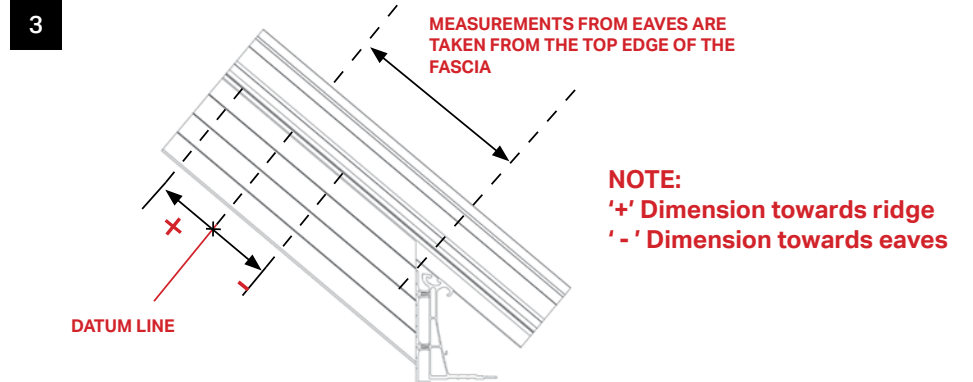

INSTALLATION - BOLSTER BARS - TRANSOM

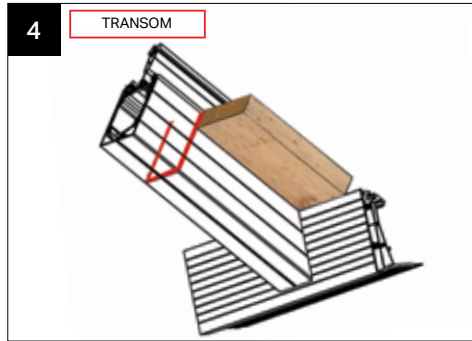

Using the location plan provided – see example in fig 1 - find the dimension for setting out bracket positions on the transom bars. Measure up the bar from the eaves beam, and mark the bolster cladding on all three sides. If your roof features many transom bars, it may be simpler to cut a piece of timber to length, to use as a template and mark using that.

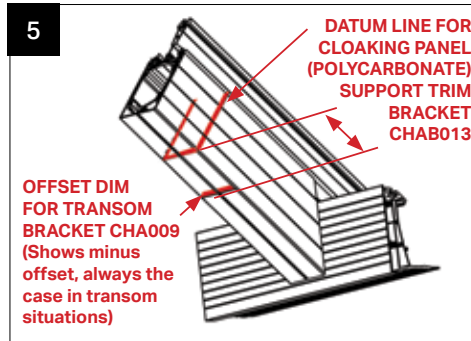

Using the bolster set out data on the location plan, mark each of the transom bars, for the bottom bracket using the offset dimension, always measuring down towards the eaves in transom situations.

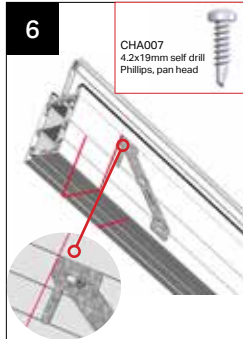

Line the bracket up with the datum line and the top of the bolster (do not bend bottom tab).

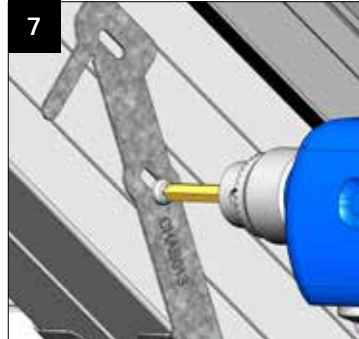

Now attach the bracket with a minimum of two CHA007 4.2 x 19mm self-drill panhead Phillips screws. Repeat the process for the other side bracket.

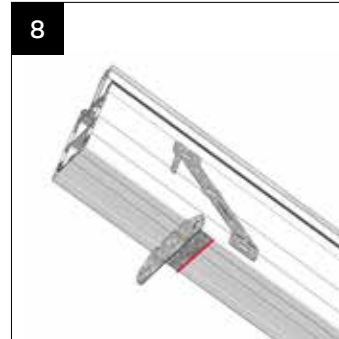

Then take the CHA009 transom bracket and line it through with the pre-marked minus offset dimension.

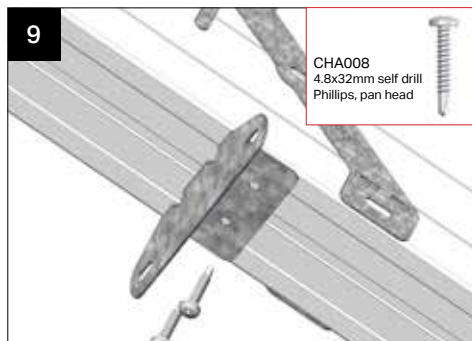

Attach with two CHA008 4.8 x 32mm self-drill panhead Phillips screws.

INSTALLATION - BOLSTER BARS - HIPS

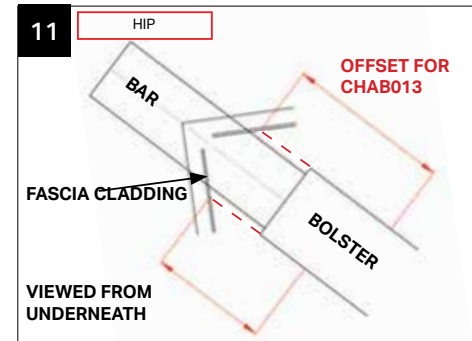

Looking from underneath the bolstered Georgian hip bar, strike a line down the side of the bolster cladding and put a datum line on top of the fascia.

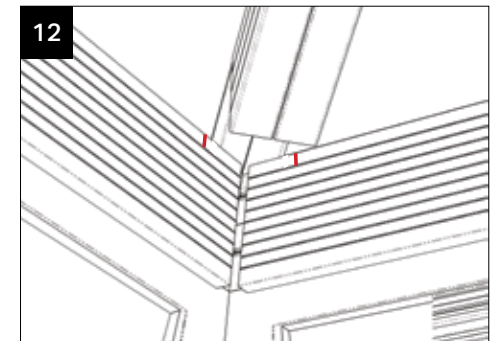

This is how it should look when you have marked each side of the eaves fascia with a datum point to measure from.

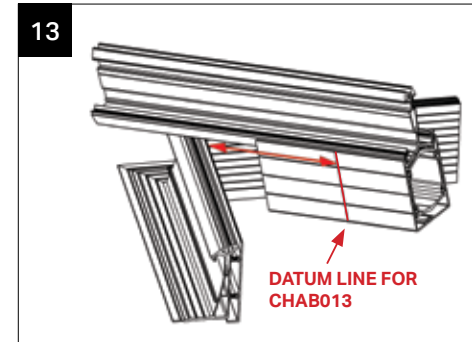

Now referring to the location plan, check the dimensions for left and right. Measure up the bar from the datum mark and mark both the side and face of the bolster cladding from the datum mark. Complete the task on left and right sides – the dimension may be different for each side.

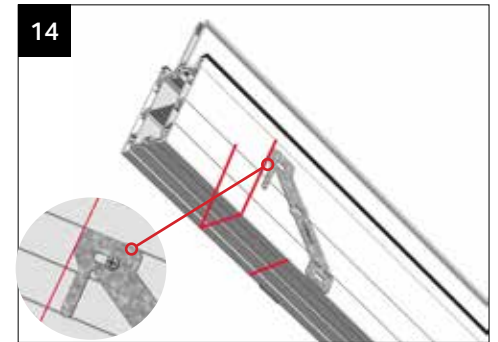

Line the bracket up with the datum line and the bottom of the bolster (do not bend bottom tab).



Once bars have been fitted, apply sealant to the inside face of the bolster endcap and tab and push onto the end of the bolster. The central tab should engage with the horizontal

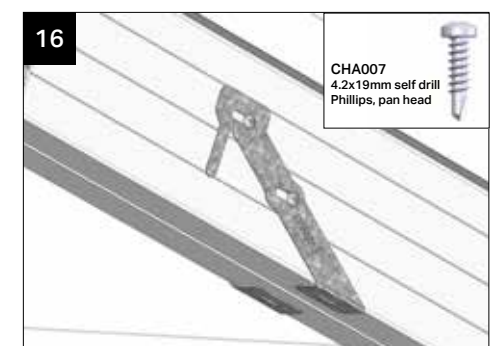

Now attach the bracket with a minimum of two CHA007 4.2 x 19 mm self drill panhead Phillips screws. Repeat the process for the opposite hand bracket.

INSTALLATION - BOLSTER BARS - TRANSOMS

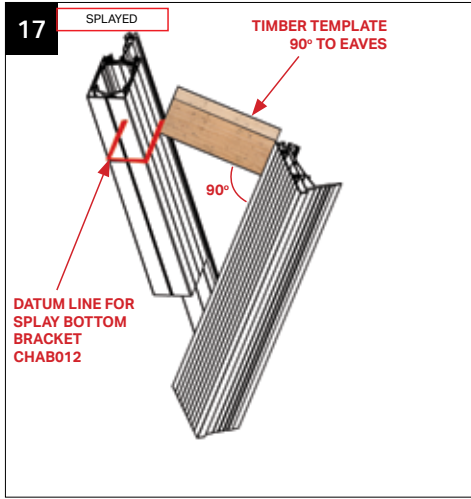

From the location plan, find the dimension for the splayed bar and cut a piece of timber to that length. Hold the timber along the top edge of the PFTC fascia board and then against the glazing. Mark a line all the way round the splayed bar cladding.

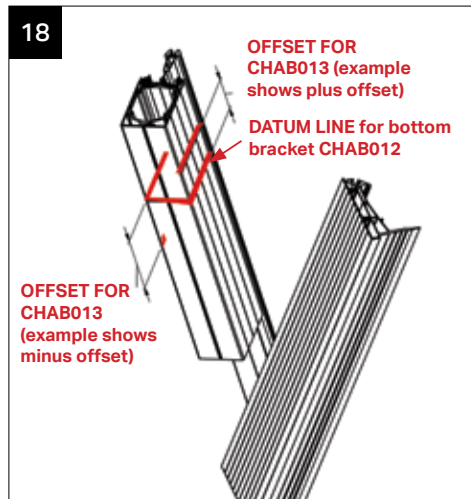

Using the location plan, measure and mark either the positive offset or the minus offset.

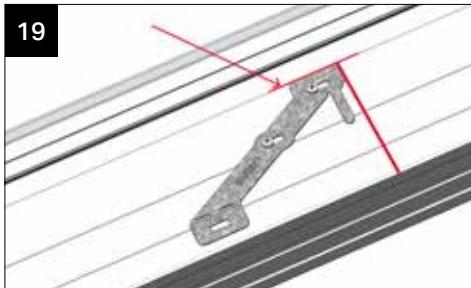

Take the bracket CHAB013 and line up with offset line and the top of bolster. Now attach the bracket with a minimum of two CHA007 4.2 x 19mm self-drill Phillips screws. Repeat the process for the opposite hand bracket.

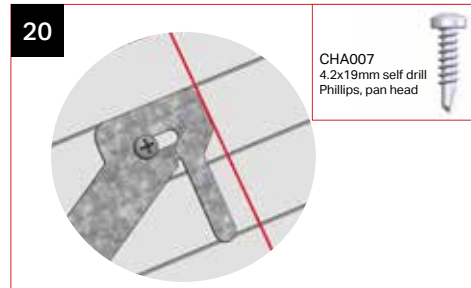

Align feature on bracket to line.

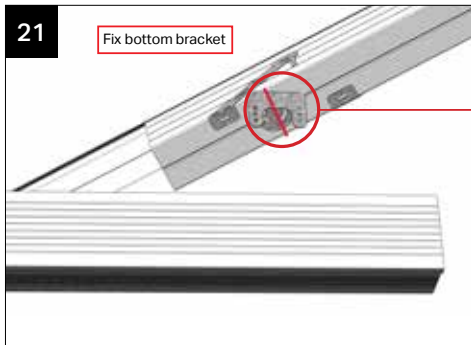

Then take the CHA012 splay bar bracket and line it up with the datum line – see illustration alongside. Fasten through centre hole with one CHA008 4.8 x 32mm self drill panhead Phillips screw.

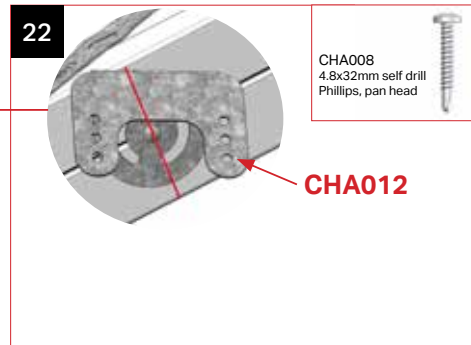

INSTALLATION - BOLSTER BARS - HIPS

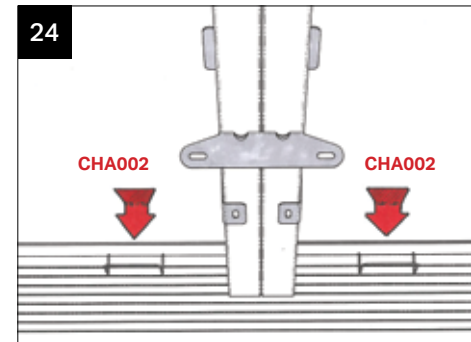
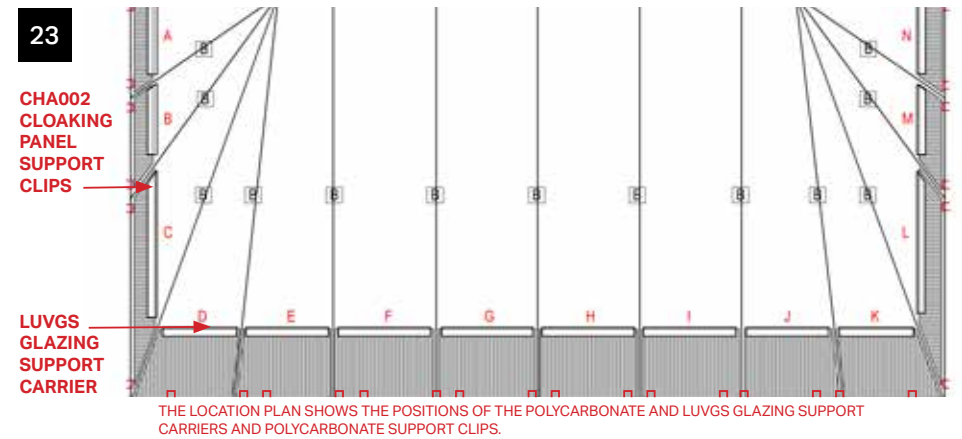

A cloaking panel (polycarbonate) support clip is placed each side of the transom bolster bars.

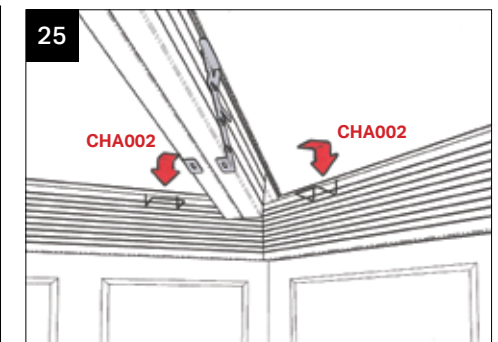

The support clips are located over the PFTC fascia board at hips and splayed bar positions too.

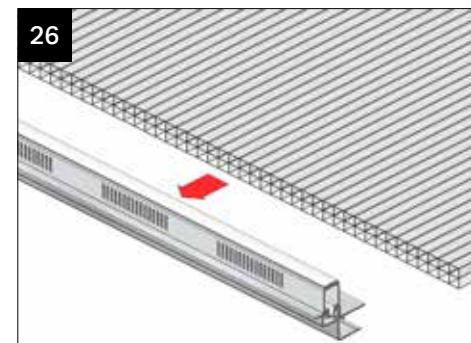

Fit the 16mm polycarbonate sheets to the corresponding LUVGS glazing support carriers, ensuring the polycarbonate flutes are perpendicular to the LUVGS. Refer to poly, LUVGS and PST offsets (page 9). Peel back one end of the tape protective film (ready to be pulled away when the sealed unit is in position).

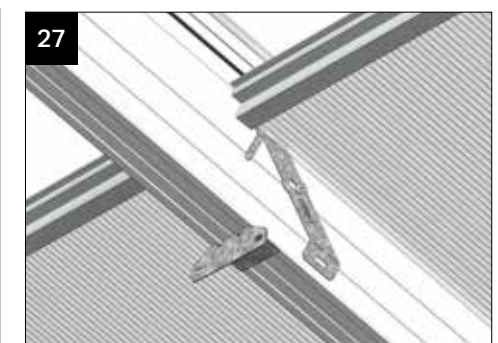

Place each polycarbonate-LUVGS assembly into its corresponding location: Sit the poly end on the support clips that are hooked over the fascia. Then push the LUVGS end up to the bars.

INSTALLATION - BOLSTER BARS

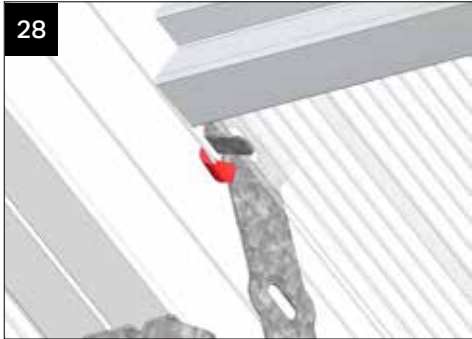

Next bend back the tabs on the CHA013 to hold the polycarbonate and LUVGS in its final position.

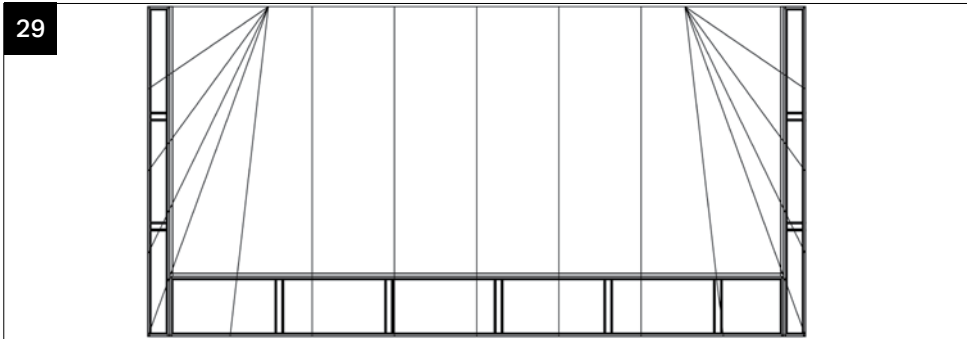

IMPORTANT NOTE. NOW CHECK ON THE LOCATION PLAN WHETHER THE HORIZONTAL FRAME IS FOR 'ON FASCIA' FIXING OR 'BELOW FASCIA' FIXING - SEE MAIN GUIDE PAGE 17, STEPS 41 AND 42.

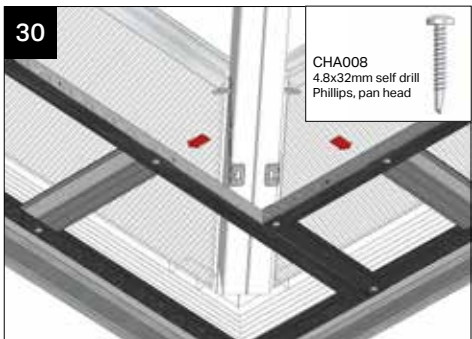

Having referred to the location plan, offer up the first horizontal ladder - a temporary timber support leg will help you here. Use 4.8 x 32mm at 250mm centres into pre punched holes to attach the ladder. Connect horizontal ladders together using two CHAA006 fixings. Add adjacent horizontal ladders.

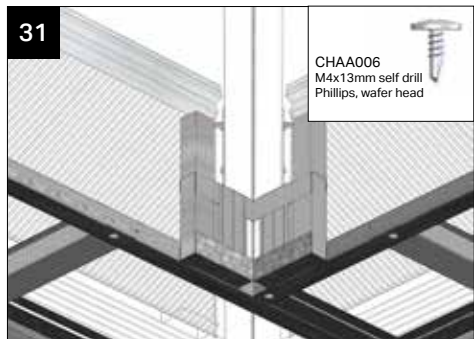

Unpack the bolster corner infill - it is supplied flat and needs to be unpacked and folded into a right angle. Taped to it are two 100mm fixing channels - place these on one side for later. Offer up the corner infill and screw through horizontal ladder into the back of the corner infill - use two CHAA006 M4 x 13mm self drill wafer head Phillips screws per side of the corner.

INSTALLATION - BOLSTER BARS

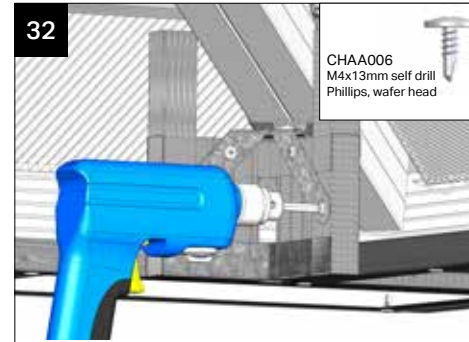

Next take the CHA010 hip bracket assembly and fasten the 'V' shaped element into the corner infill using 4 CHAA006 M4 x 13mm self drill wafer head Phillips screws.

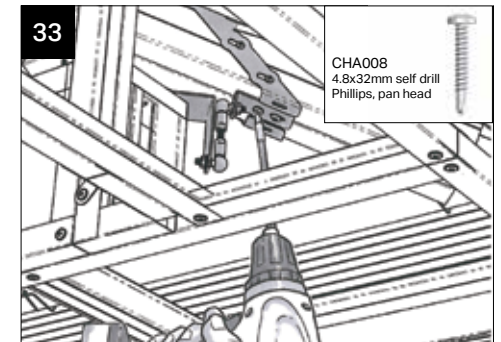

Now, screw up through the horizontal ladders to complete the assembly of the CHA010 hip bracket assembly using two CHAA008 4.8 x 32mm self drill panhead Phillips screws. Ensure horizontal ladders are level.

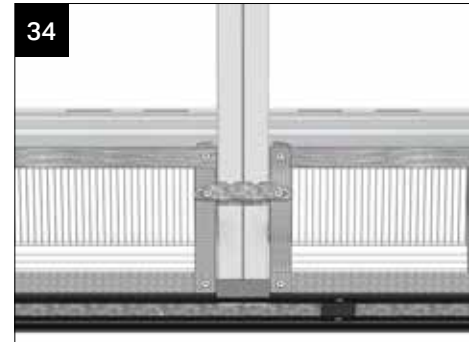

This is what the final transom bar should look like.

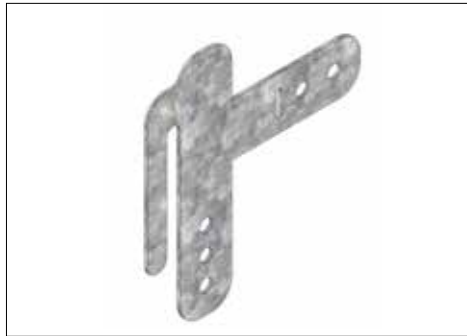

GABLE BRACKET (CHA019)



1 Using the location plan provided find the dimension for setting out the clip positions for the gable brackets. Measure up the bar from top edge of the fascia board and mark it.

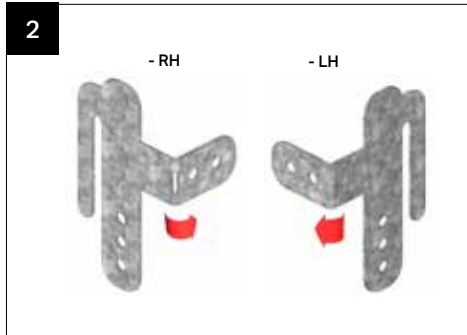

2 Bend the CHAB019 tab at a 90-degree angle at the slot. The direction will depend on whether it's a right- or left-handed part.

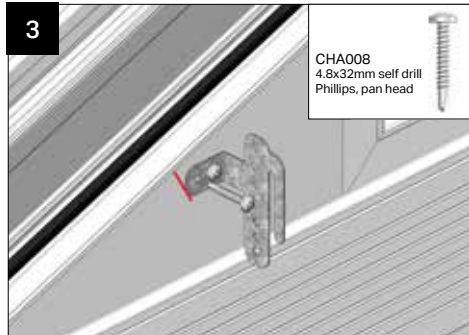

3 Take the gable bracket (CHA019 right hand shown). The back edge of the bracket should butt up to the pencil line. Align the top face of the gable bracket with underside of starter bar cladding.

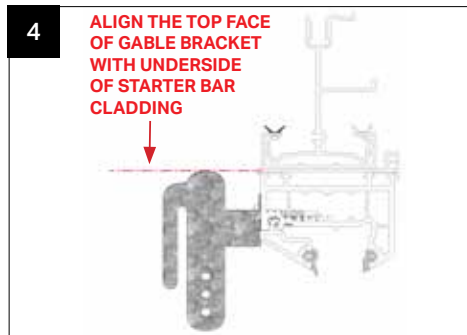

4 Attach gable bracket to frame using two of the CHA008 (4.8 x 32mm) self drill Phillips Pan Head screws supplied.

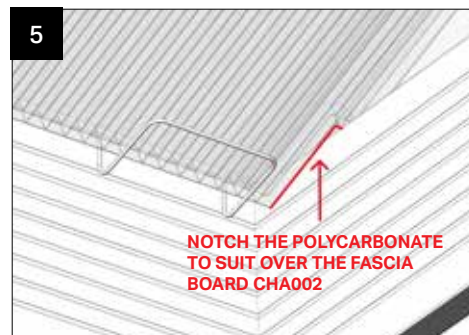

5 Referring to the location plan, place the polycarbonate-LUVGS assembly into its corresponding locations: Mark and notch the corner of polycarbonate as demonstrated.

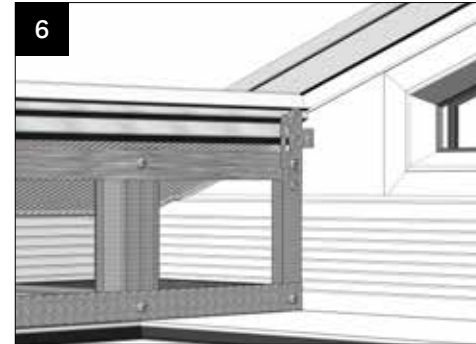





6 Fit the horizontal and vertical frames as shown in the main internal insulated pelmet installation guide. (pages 17 and 18).



7 Fix the vertical frame into the fascia board using 2x CHAA006 (M4 x 13mm) self drill Phillips, wafer head screws (supplied).

INSTALLATION - VALLEY

VALLEY BRACKET KIT CONTENT CHA014				No. Req
	Valley Fixing Plate	CHA016		x1
	WSR 4.8x70 Z Self Tapping Drill Point	CHA017		x2
	200x100x27x2.5 Thick Galvanised MS Strap	CHA018		x1
	Bag of 25 - M4 x 13 Self Drill Philips Wafer	CHAA006		x1

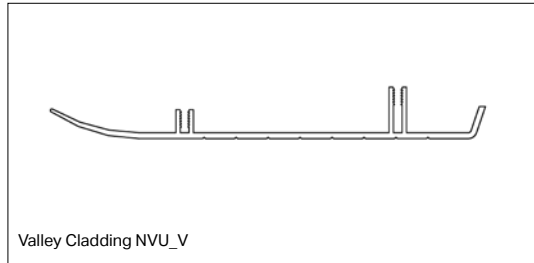

NOTE: The transom bracket CHAB001 **MUST** be trimmed and adapted to suit situations where a transom bar, valley and internal insulated pelmet vertical frame intercept, as shown above.

INSTALLATION - VALLEY



Mark out and cut the valley cladding and fix valley fixing plate by following steps 1 - 5.



Using a level, plumb up off the horizontal frame and mark the outer bottom edge of the valley cladding on both sides (Mark "A").

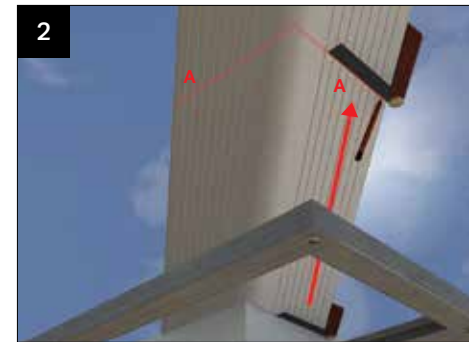

Using an angle finder (or joiners bevel). Draw a line on the valley cladding from the mark 'A' parallel to the eaves.

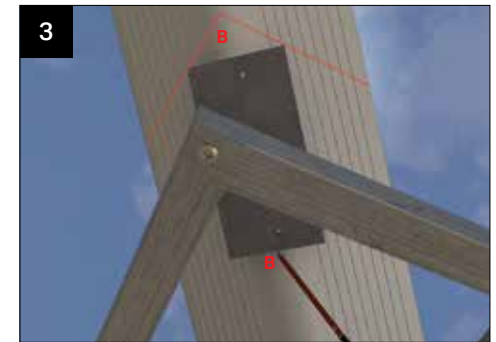

Temporarily position the valley fixing plate central of the valley with the top edges touching the marked lines. Mark either side of the plate (shown as 'B' on the cladding). Now remove valley fixing plate.

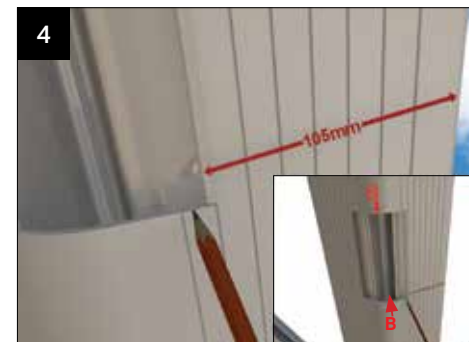

Then measure 105mm in from each side of the valley cladding and extend mark B top and bottom to form pencil rectangle. Cut out valley cladding.



Fit valley plate as shown to the valley wing central connector using CHA017 (2x4.8x70 self tapping screws).

NOTE: FOAM SIDE POSITION TOWARDS THE VALLEY.

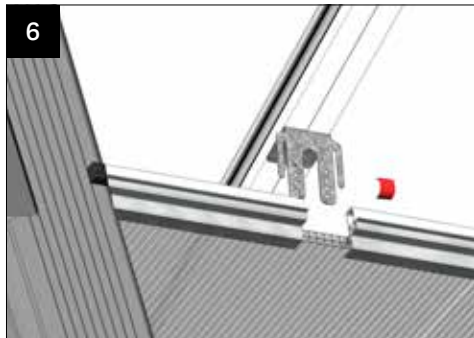

6 Attach the appropriate polycarbonate-LUVGS panels and fit as shown in the main internal insulated pelmet installation guide. (page 16).



7 Fit the valley corner infill panel to the horizontal frame, level up and secure to the valley plate.



8 FIT THE STRAP CHA018 USING M4x13 SELF DRILL SCREWS, to the valley corner infill panel and the valley fixing plate. It may be necessary to bend CHA008 to suit.



9 Fit the vertical frames. Fix the frames into the valley corner infill and the horizontal frames.



10 Using the bracket positions, level through and mark off the valley marked 'C'.



11 Measure and fit the standard valley undercladding NVU-V between the eaves and mark 'C'. Scribe to suit.



12 Fit the valley plate CHA016 (refer to steps 1-5, valley standard classic).



13 Valley infill panel fitted to horizontal frame, as image 10.

INSTALLATION - INTEGRAL BOXGUTTER



1
If not already fitted, attach box gutter insulation foam to the upper section of box gutter.



2
Fit length of LHE---/2 to the upper section of box gutter.



3
Using LHE---/2 as a datum, measure and mark the positions of the brackets in line with the dimensions given in the provided paperwork.



3a
FITTER TIP: If possible, check and line through with the bracket position on the adjacent full length bar. Mark the bracket positions on the bars off the box gutter.



4
Fit brackets in marked positions on the bars as per standard installation

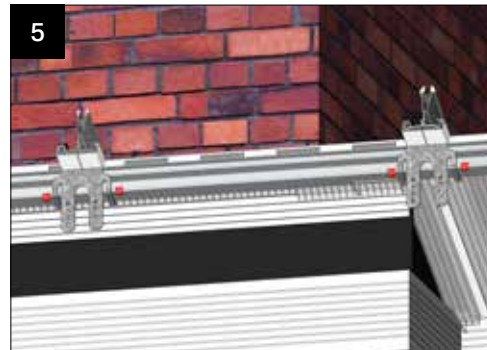

5
Fit the appropriate polycarbonate-LUVGS panels as shown in the main internal insulated pelmet installation guide (page 16) and bend the bracket legs to secure.



Scan the QR code to
watch a Wendland
Glass Roof installation.

www.wendland.uk.com

© Wendland - Our policy is one of continuous improvement and we reserve the right to change specification and design at any time without prior notice.

Job No. 3705 WENDLAND INSTALL V13 08/25 HC-WIG001

