

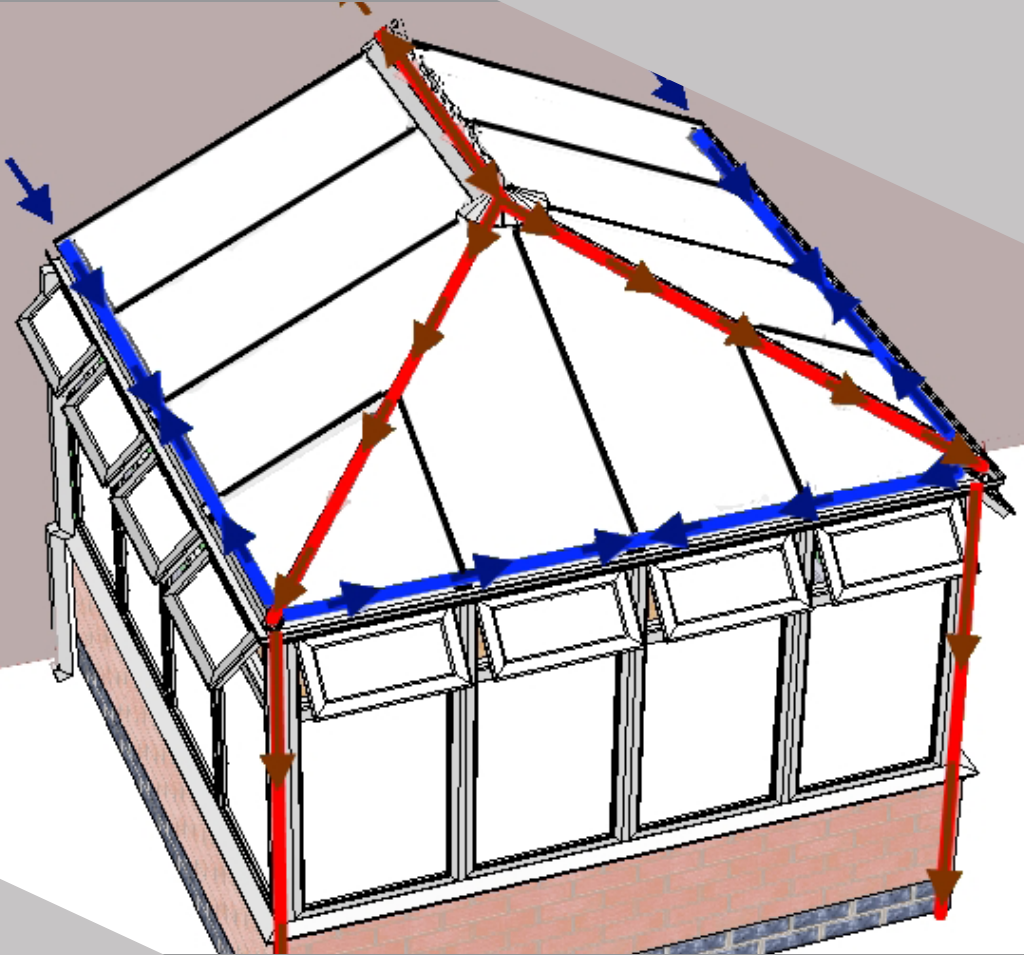

# WENDLAND

R O O F S O L U T I O N S



## Glass Roof Surveyors Guide

V4 | August 2024

# WELCOME

This guide has been written for those who survey, design and order conservatories, glass extensions, orangeries using the Wendland roofing systems.

The objectives of this guide are that you will be able to:

- A) Professionally conduct an on-site survey
- B) Design and draw all roofs, frames, sill and base details
- C) Translate all dimensions taken into manufacturing sizes
- D) Confirm all details are to the satisfaction of the customer

It is recognised that basework construction methods vary in different areas of the country and this guide may need to be adapted to suit your own on-site requirements.

There are a number of Wendland brochures that need to be referenced in conjunction with this guide.

## CONTENTS

<b>Surveying The Site</b>	<b>3 - 6</b>
<b>Site Survey Checklist</b>	<b>7 - 8</b>
<b>Designing The Base</b>	<b>9 - 11</b>
<b>Designing The Doors and Frames</b>	<b>12 - 13</b>
<b>Designing The Glass Roof</b>	<b>14 - 16</b>
<b>Box gutter supports</b>	<b>17</b>
<b>Bolster gallows brackets</b>	<b>18</b>
<b>Conservaflash</b>	<b>19</b>
<b>Ridge</b>	<b>20 - 22</b>
<b>Valley</b>	<b>23</b>
<b>Glazing bars</b>	<b>24</b>
<b>Eaves beam, cornice and box gutter measurements</b>	<b>25 - 26</b>
<b>Gallow bracket and hanging bracket measurements</b>	<b>27</b>
<b>Bi fold support beam &amp; eaves super bolster</b>	<b>27</b>
<b>Chambered glazing bar measurements</b>	<b>28</b>
<b>Ridge and wall plate measurements</b>	<b>29</b>
<b>Box gutter adaptors, rainwater outlets</b>	<b>30 - 32</b>

This surveyors guide should **always** be read in conjunction with our other guides and VS software such as the technical guide, installation guide.

## Accreditations



Within some projects there are critical structural elements such as 'goal post' beams and supports which are used around large bi folding doors or to support box gutters where a glazed roof meets a wall or other roof. These crucial structural components now have to be CE Marked and Wendland's manufactured items have this accreditation.

Wendland operates a quality system which means it is independently assessed every quarter by BSI. This means an audit by trained inspectors to ensure we design, manufacture and supply in accordance with ISO 9001:2008 quality standard.

## SURVEYING THE SITE

### The Surveyor's Role

To confirm all details agreed between the salesperson and the houseowner which is a very responsible role. Great care and skill is needed to translate all the information agreed between the conservatory designer (salesperson) and the houseowner. **All contracts are subject to final survey and planning/building regulation approval (if needed) before any construction or manufacturing procedures take place.**

### Step one - SITE VISIT

**Agree a suitable time for the survey with the houseowner during "Day-light" hours.**

You will need

- A) A4 Graph paper and pen / pencil
  - B) A tape measure or telescopic ruler / measuring rod
  - C) A level (1200 mm preferably)
  - D) A digital angle meter
  - E) A straight edge (the longer the better)
  - F) A telescopic ladder / collapsible ladder
  - G) A camera
- A laser level and laser distance measurer is recommended on larger projects.

**Be Aware** - If when preparing the groundwork for the conservatory footings excavation is necessary, you may need a skip. Is there room to park a skip on the drive or on the highway? If on the highway you will need permission from the local authority. If left overnight it will need to be lit.

**Take Note** - If mixing your own concrete or using an extension lead is there a socket to plug the mixer into? Is there a tap to add water to the mixer?

### Step Three

#### - INSPECTING THE EXISTING PROPERTY

Is there an existing patio area to dig up? Is there an existing structure to remove / demolish? Will existing garden walls or fences need to be moved? You may need a skip for any one of the above. Will existing flower beds or ornamental ponds be affected? Inform the customer and ask them to deal with them prior to commencement of groundwork.

If pebble dashed or rendered, are there any "hair-line" cracks evident? Settlement cracks between bay windows? If there are, ensure you point them out to your customer and if need be, photograph them. If you don't the customer may hold you responsible after installation, camera is ideal for this purpose.

### Step two - SITE ACCESS

#### BE OBSERVANT - BE AWARE - TAKE NOTE!

**Be Observant** - Is there access to the rear of the property? If a terrace row, is there access from a back street or will all goods, have to be taken through the house? If a semi-detached, is there a path down the side? If there's a drive, is it wide enough? If there's a garage on the drive, is there a back door to take materials through and is it wide enough?

Careful attention is required, we really don't want to lift materials over the garage roof or have to ask the next door neighbour to lift materials over their fence!

### THE BEST WAY TO SURVEY

The best way to survey a property is to sketch out a plan and an elevation of the proposed site showing all existing windows, pipes, drains and other possible obstructions - (see sketch).

The dimensions between each feature should be indicated and the position of the proposed conservatory.

If you are carrying out several surveys in a day and drawing the results up at a later time, it is a good idea to reinforce your survey sketch with a photograph of the site.

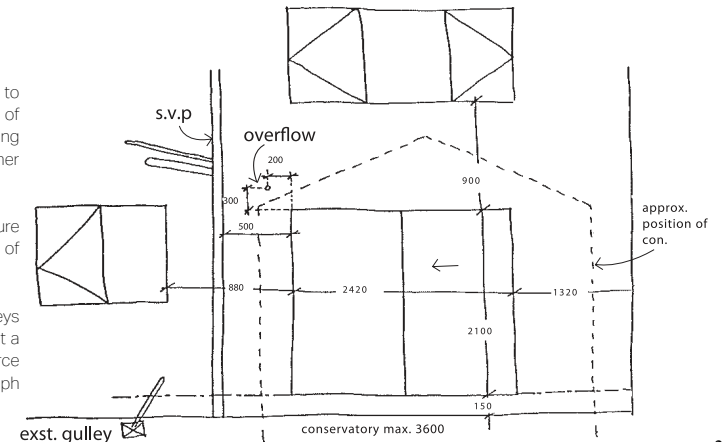

## SURVEYING THE SITE

Take note of the brickwork type and condition.

**Is the brickwork still available? Does the customer want a matching dwarf wall? How old is the property? How many years weathering has the brickwork endured?** Always offer a selection of brickwork to the customer and let them choose. Place the onus on the customer. It may not be possible to match the brick, often a contrast is the safest option. You may consider using squint bricks or stone quoins or bricks which are cut and bonded to form your angles.

### Water penetration problem

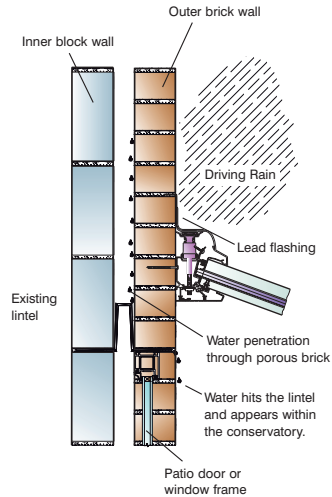

### Water penetration solution

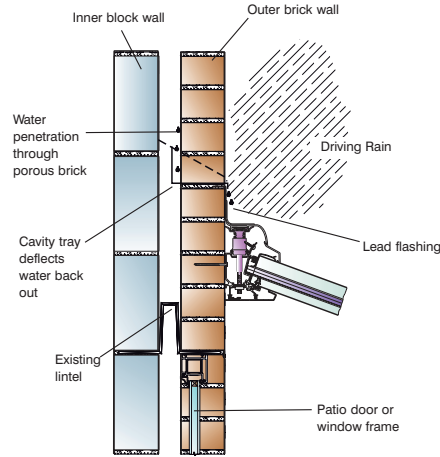

The bricks used in the construction of many modern homes are very porous. In any case all brickwork elevations are subject to water penetration. Therefore consider the installation of a cavity tray. This is often overlooked and is more difficult and expensive to install after the conservatory has been built. If the elevation on which the conservatory is to be built is exposed to the weather, a cavity tray must always be recommended to your customer. A cavity tray should always be considered when constructing a conservatory on a new house that is covered by the Ten Year NHBC (National House Building Council) Buildmark Guarantee. Any problem occurring from water ingress due to the lack of a cavity tray will not be covered by the NHBC Guarantee.

If for whatever reason a cavity tray cannot be installed, a minimum requirement would be a vertical soaker up off the roofline (75 - 150mm) then dressed back over with Code 4 lead, ground at least 25mm into the host wall. Lead should be treated with patination oil. If

abuting a rendered or pebbledashed elevation it would be proactive to fully seal the elevation with a proprietary clear silicone based sealant prior to installing the conservatory, rather than reacting to a later problem of damp penetration.

If installing against a bungalow fascia the existing soffit may become a part of the conservatory. If the bungalow roofing felt laid above the soffit board in the area of the proposed conservatory deteriorates this may result in the felt sagging and water ingress may occur. See detail below. If this happens, you unfortunately inherit the problem. You should at survey lift the lower roof tiles and inspect the felt. If perished, this should be pointed out to your customer and give them the option of replacing the felt with either Monoflex, DPC or one of the many proprietary products available.

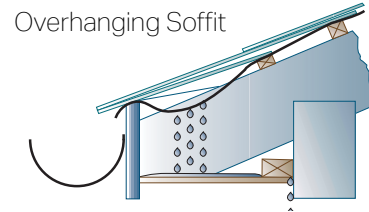
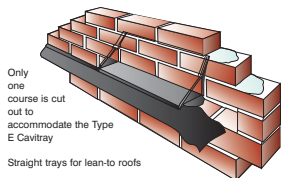
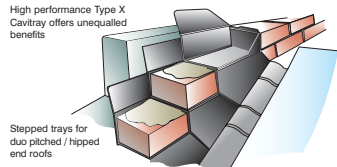

## SURVEYING THE SITE

### Step 4 - THE HOUSE WALL

**Conservatories should be designed from the roof down.** However there are conditions that dictate starting from the basework working upward i.e. constructing off existing basework, between fixed walls or the base position has to be there! This part of the survey is best conducted without the distraction of the customer present.

#### IS THE HOUSE WALL VERTICALLY PLUMB?

If the house wall leans forward: when the conservatory ridge butts to the house wall, the whole conservatory will be pushed forward of the basework, resulting in excessive overhang and incorrect angles. See diagram 'A'

If the house wall leans backward - then the conservatory dimensions need taking from top of the Dwarf Wall and a suitable tapered packer inserted between frames and house wall. See diagram 'B'

If vertically plumb - A standard 90° corner post fixed to the rear of both side frames which abut the house wall is a good idea. For example, should you wish to bring a RWP down the frame as opposed to returning on 'The House Wall'. It is also very useful should you wish to plaster or dry-line the inner house wall.



Diagram A



Diagram B

conditions. As a minimum requirement, foundations shall comply to BS 8004 (section 3: Shallow Foundations), and shall comply with any appropriate building regulations. In areas where harmful gases are a concern (eg Radon) expert guidance should be sought. If in any doubt contact your local authority Building Control Office.

Problems to the basework are, more often than not, hidden from sight. The obvious problems are gullies and manholes. It is not always possible to move an existing manhole due to its depth and run of the drainage system. The ideal solution is to raise the manhole to the height of the conservatory floor and fit a sealed (airtight) manhole cover which is suitable for internal use. These can be obtained with a tray top which will accept tiles or carpet to disguise the cover. (If a timber floor is to be fitted then a suitable hatch needs to be installed) Access to manholes is a legal requirement. Try to work out the position and direction of underground drainage pipes by following the run from the soil stack and other waste pipes to any manholes which are visible.

If necessary lift the manhole cover to check the depth and direction of all the drainage. Flushing a coloured drain dye or milk may help if there is any doubt about this. Be aware that manholes are sometimes covered by the DIY or 'cowboy' patio builder. If an existing drain runs under the proposed conservatory it will have to be encased in pea gravel then concrete and possibly a lintel bridged over the drain if being crossed by a dwarf wall.

Note: Terraced houses with back yards need careful consideration. Beware of the public sewer running through each back yard. You will always need a 'Building over sewer agreement'. Again, check with your local authority Building Control Office.

### Step 6 - CUSTOMER INVOLVEMENT

**Once all the possible problems have been identified this is the best time to involve the customer.** Discuss your findings with the customer and always "plot out" the proposed conservatory with the customer present. If necessary use stones or pegs to illustrate the size and shape of the conservatory. Always make sure that when discussing dimensions with the customer, you qualify the differences between the external base size and the internal floor area. Also confirm the height of the dwarf wall above finished floor level, if required.

Note: When deciding on the dwarf wall height take into consideration the "lie of the land", generally, if the garden slopes downhill make the dwarf wall shorter. If the garden slopes uphill, maybe higher? When the customer is sitting down, can they comfortably see over the wall to the garden?

It is good practice to ask the homeowner to notify their insurance company that work is taking place at their home. Also once installed the insurance company need to be notified for them to assess the increased value and subsequent re-building costs.

Observe the elevation: Is the upper elevation rendered and lower elevation facing brick? Are there any projecting brick plinths or bell casts which may affect the design of the conservatory? Check the position of rain water pipes, cables, air bricks, extractors, soil vent pipes and, of course, existing window and door openings. Moving soil vent pipes can be very expensive and will require building regulation approval.

If moving an obstruction is not feasible, then it may be necessary to cater for the obstruction when designing the conservatory. Soil vent pipe flashing kits are readily available. These are designed to fit around the stack and seal to the roof line. Fan assisted balanced flues are also a particular problem and it is extremely important not to build too close to these as it may affect their efficiency and the safety of the householder. British Gas Services Ltd state: A minimum distance of 300mm clearance below or to the side of an openable window or other opening eg. air brick/ trickle vent/extractor (maximum heat input up to 60 kw), 600mm for a natural draught flue. Advice should always be sought from a Gas Safe Registered Engineer prior to designing.

**Note: The heat generated from a flue outlet can distort PVCu Cills etc. The fitting of a deflector would be advised.**

### Step 5 - GROUND PREPARATION

**Careful attention to groundwork preparation is essential.** Depth of foundations are always dependent on local ground

## SURVEYING THE SITE

### Compressions and tensions explained.

When a tie bar is located under the finial point, it provides rigid support to that end of the ridge. If no tie bar is there, the hip bars support the ridge instead. This puts the hip bars in to compression. These push outwards at the external eaves corner connection. As a result of this, the eaves beams down either side of the conservatory are now trying to pull away from the house. To maintain the equilibrium of forces, the ridge must therefore go in to compression and pushes against the host wall. These forces are shown graphically in the diagram below. If the host wall runs in, or away, the bars will not support the end of the ridge and compression cannot be established. If the load cannot be transferred down through the hip bars, it will displace it down through the side (transom bars). Due to the fact that side frames have very little lateral stability on there own, the eaves beam will bow due to the stress and this will result in ridge dip.

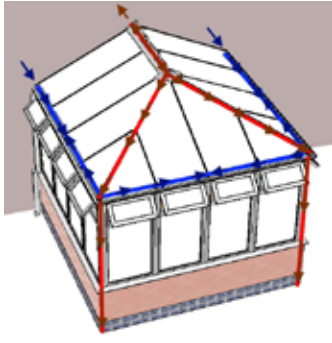

**Diagram of the forces and load paths when a roof without a tie bar is loaded (downward load) - Compression in red, tension in blue.**

### Fixings into the host wall

The type of fixings required when installing a conservatory is entirely the responsibility of the installer. Brick, block and masonry substrates vary widely in quality; the performance of an anchor primarily depends upon the integrity and strength of the substrate material into which it is fixed. In general, the stronger the substrate, the greater the load will be before failure.

There are two typical kinds of load to consider. The first is tensile load, also described as 'pull-out' where a force would be required to pull a fixing out of its hole i.e. along its axis. The second is shear, where the force is at right angles to the fixing.

Torque controlled expansion anchors are far superior in performance than 'hammer-in' screw fixings, being typically in excess of 10x stronger for the same diameter.

The starter or wall plate bars require a positive fix at several points i.e. in close proximity to the eaves beam & ridge & at regular centres in between, the spacing are dependent on the type & condition of the wall. Weak, badly situated or insufficient fixings could fail & be pulled from the wall causing the frames/ eaves beam to be pushed forward & allowing the ridge to drop.

### Structural Frames in conservatories.

It is your responsibility to ensure that all supporting framework and walls provide adequate lateral support in line with BBA certificate No. 96/3261.

The overall stability of the conservatory is to be proven by others and in this respect I advise you or ask you to advise your client to employ a Structural or Civil Engineer to check the conservatory for stability. Please do this before works start on site to avoid any corrective works being required.

The side frames/walls must provide conservatories with overall lateral stability and resistance to axial loading. Advice should be sought from the frame supplier for the specific use of members for the conservatory construction.

To fulfil the requirements of lateral stability on a 'free standing' roof, we would recommend the inclusion of Brick Piers or Portal Framework. These should be designed to the appropriate British standards, by suitably qualified personnel.

If you require we would be happy to specify and cost for an appropriate Portal Frame Structure for this particular project. However if the supporting sections are to be sourced elsewhere, we cannot provide these designs or calculations as standard.

## SITE SURVEY CHECKLIST

### Conservatory site survey checklist - side 1

Photocopy this page for each site survey and file for reference	YES	NO	COMMENTS
1) Is planning permission or building regulation approval needed? If yes, who will apply?			
2) Is there sufficient access to the proposed conservatory? Including height and width restrictions for delivery of material, concrete, frames, glass & welded cills etc?			
3) Will construction involve crossing any public or neighbours path, garden, wall or hedge?			
4) Are there any existing structures to demolish?			
5) Will you need a skip on site?			
6) Is there an existing patio or path to be removed?			
7) Is there an existing retaining wall - will this need re-constructing?			
8) Are there plants, bushes, fish-ponds in the way?			
9) Are there any other visible obstructions on the ground?			
10) Is the house wall sufficiently out of plumb to require any allowance in the design of the conservatory?			
11) Are there any projecting bell casts, soldier courses, key stones in the way?			
12) Are there any signs of settlement or hairline cracks in the house wall - have these been pointed out to the customer?			
13) Is there a soil vent pipe, RWP, extractor fan or gas flue in the way of the proposed conservatory?			
14) Are there any TV, satellite or telephone cables in the way?			
15) Are there any existing window or door openings to be moved, altered or bricked up?			
16) New openings to existing property will require new lintels which will require building regulation approval.			
17) Are there any existing window or door openings to be included within the newly proposed conservatory? Very important if specifying a tie bar replacement kit. See Pg22.			
18) Are there air bricks or head ventilators in the existing property which will be encompassed within the new conservatory?			
19) If yes to question 18, these must be transferred through the proposed conservatory.			
20) What is the existing external wall finish: Facing brick, stone, render or pebbledash?			
21) If facing brick, is a cavity tray required?			
22) Is there a height restriction above the proposed conservatory ie. a bedroom window?			
23) Is there enough room above the ridge flashing trim to lead flash?			

# SITE SURVEY CHECKLIST

## Conservatory site survey checklist - side 2

Photocopy this page for each site survey and file for reference

	YES	NO	COMMENTS
24) If installing to a bungalow fascia, lift the front row of tiles and check the roofing felt over the projecting eaves.			
25) Will the conservatory roof fit below the bungalow soffit board?			
26) Will the conservatory roof fit to the bungalow fascia board?			
27) Is the fascia deep enough and in good enough condition?			
28) When installing a roof to the fascia is there enough room to re-fit the existing gutter?			
29) Will you need to install a vertical damp proof course where the side frames abut the house/bungalow wall?			
30) Is the conservatory rainwater to discharge into an existing gully?			
31) Is a new gully required (connected to the existing system or to a new soakaway)?			
32) Is there a sufficient number of rainwater outlets for the size of roof?			
33) Is there an existing gully to move?			
34) Are there any existing underground drainage pipes to be moved?			
35) Are there any existing underground drainage pipes to be built over?			
36) Is there an existing manhole to be moved?			
37) Is there an existing manhole to be raised to the conservatory floor level then sealed with an airtight cover?			
38) Are there any pipes or cables to be catered for in the proposed build?			
39) Is the proposed level of the conservatory floor the same level as the house floor level?			
40) Will the difference in house floor level and the proposed conservatory floor level require steps?			
41) Will the difference between the proposed conservatory floor level and the outside ground floor level need a landing, steps and handrail?			
42) Is a dwarf wall required - what height?			
43) Are there squint bricks or stone quoins required or will you cut and bond bricks?			
44) Are there any new openings required in the proposed basework for doors?			
45) Is the site sloping away requiring extra height to the basework?			
46) Is the site sloping towards the basework requiring excavation?			
47) Will a retaining wall be needed?			
48) Is a new path or patio area required?			
49) Check coursing and spacing of brickwork against existing - ie Imperial or Metric			
50) Has all the detail been discussed and agreed with the customer			

# DESIGNING THE BASE

**The difference between the house floor level and external ground level should be measured. Check also the position of the house damp proof course. If the conservatory finished floor is to be level with the house floor and this is more than 150mm above the external ground level, then steps will be needed.**

Sloping sites can produce several possible problems. For instance, if the ground level is much lower than the proposed conservatory floor level, then it may not be feasible to install a solid floor in the conservatory due to the infill required. If a suspended floor is required this will add to the cost of the basework. If french doors or a single door open out and the land falls away, you will need to build a landing/platform (generally the width of the door(s) and the depth of the opening door, ie. 900mm + 400mm = 1300mm deep) for the customer to safely step out onto before walking down steps. Should the steps be higher than 600mm you will need to produce a hand-rail / balustrades. Approximately one step is required for every 150mm increment in height. This work should always conform to building regulations. Depending on which way the site is sloping, it could require additional height to the conservatory base wall.

Class B engineering bricks or similar should be used up to DPC level with concrete commons or concrete blocks being used underground and stepped if necessary. Alternatively, it may require part of the site to be excavated and a retaining wall built before the conservatory will fit.

It is advisable to start with the external base dimensions when designing the conservatory, as these are usually the largest dimensions on plan. (Except for the footings underground.)

## Land falling away from conservatory

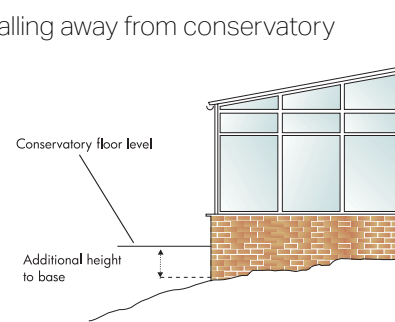

## Land falling towards conservatory

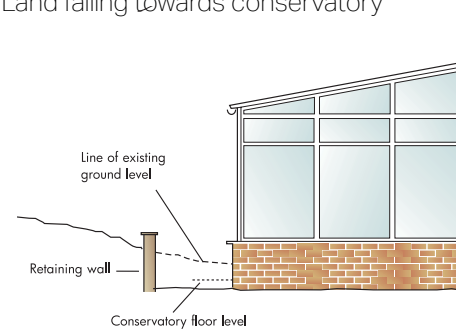

## Setting out tips

1. Example Base Plan When building to a base plan as shown, to achieve accuracy of angles when setting out the base some people use templates or build to the welded cill. Welded cills are flimsy and not the most accurate method. Follow these steps for the best results, using the formulas below.

$$\begin{aligned} \text{Facet size} &= 3500 \div 2.4142 = 1450 \\ \text{Bay projection} &= 1450 \div 1.4142 = 1025 \\ \text{Long side} &= 4000 - 1025 = 2975 \end{aligned}$$

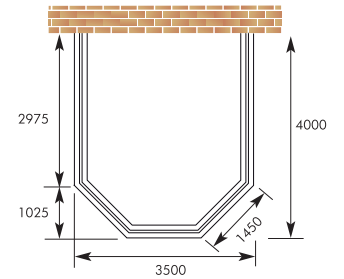

2. Set string lines for the external face of the brick to the overall width and projection. Check diagonals for being square.

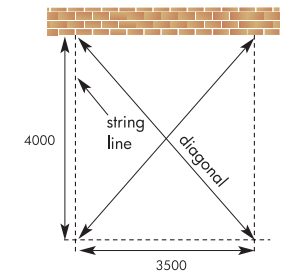

3. Measure back equally from each corner 1025mm as shown and set two more string lines. This will result in equal facets and 135° angles each time.

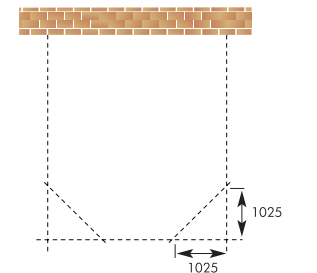

## DESIGNING THE BASE

### Dwarf Wall

**Most customers prefer a dwarf wall rather than the window frames of the conservatory sitting down to floor level. One disadvantage of a dwarf wall over full frames is that it reduces the internal floor area of the conservatory. This may be a consideration if the overall external size of the conservatory is restricted.**

Another alternative is to "dry line" the inner wall, (which avoids a 'wet trade' and allows easy access to run electric cables or heating pipe work) this will also increase the inner floor area. However, the majority prefer a double skin dwarf wall to full height frames. The dwarf wall creates an impression of the conservatory being a part of the original house. Also the dwarf wall offers the advantage of an internal window cill or if high enough, a window seat.

The height of the dwarf wall needs to be carefully considered. This is usually expressed as a height above the floor level of the conservatory. The most popular heights are 450mm or 600mm. When discussing the height ensure you measure from DPC or conservatory floor level upwards, not from the outside ground level.

Where a dwarf wall abuts the host wall, a vertical DPC should be installed from the horizontal DPC in a vertical line (on the centre line of the abutting window/door frame) to the intersection of the roof line Code 4 leading/cavity tray.

**Take note: does the garden fall away, then the wall height would be better at 450mm high, so that the customer when sat down can see over the wall into the garden. If the land is level then perhaps 600mm high. If sloping uphill then maybe higher? Also ensure you match the coursing to correspond with the original house. On modern property the coursing is usually in increments of 75mm. On older properties imperial sized bricks may have been used, these may be difficult or impossible to obtain and the modern metric equivalent may not course in.**

**Also note the vertical gap between the bricks. Are they tightly bonded, say 5mm. Does the customer want the dwarf wall base to match the house or built to standard width joints.**

When abutting the dwarf wall to the host wall a proprietary stainless steel wall connector should be used.

#### MIX GUIDELINES

Concrete 1 (cement) 2 (grit sand) 4 (20mm clean chip stone).

Brick mortar 1 (cement) 4 (building sand).

Stone mortar 1 (cement) 1 (lime) 4 (building sand)

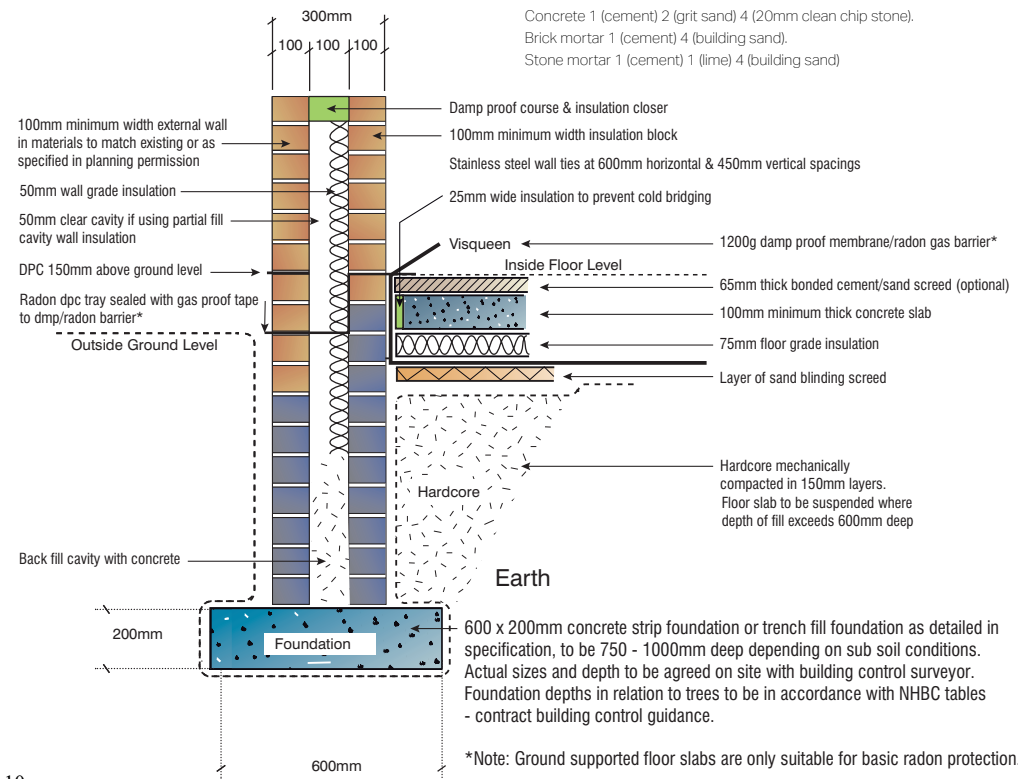

## DESIGNING THE BASE

### Concrete Plinth

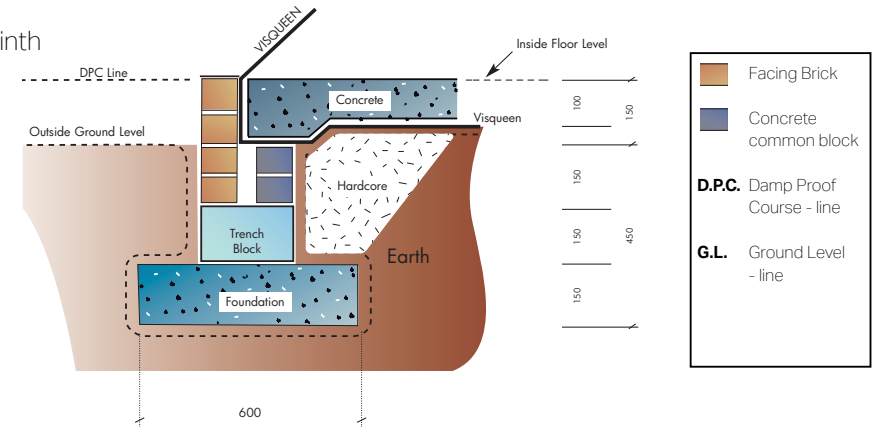

### Positioning of doors

**Many customers request the position of the doors in the conservatory as example A (below) with the doors in one of the front bay facets.**

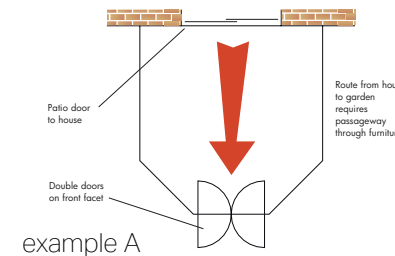

**A 100mm wide blockboard template which mirrors the outside face of the outer skin of brickwork, identical to the front facets only and returned 450mm down each side leg, then fully braced, is both cheap to manufacture and easily stored for further use.**

It is far easier and cost effective to construct the door opening to be as near as possible to the door exit from the house wherever possible (as in example B, below).

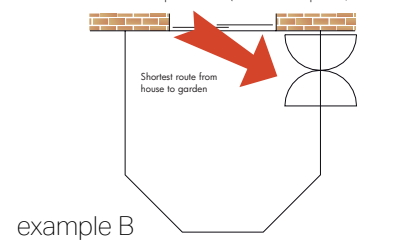

Example A will create a problem for the builder if the conservatory is sitting on a dwarf wall. The corners of the brickwork in the position of the door opening have to be calculated to suit the relevant frame and cornerpost system being used. Having this 'break' in the ring of brickwork also weakens the structure. Sending out a welded PVCu cill to act as a template for the bricklayer is not recommended for the following reasons:

- A) A welded cill in one piece is usually too large to transport
- B) It is too flexible
- C) It may be damaged
- D) With doors in the centre, the cill would be in two halves

Practically, the customer benefits too, having a much larger area in which to arrange their furniture layout. Example 'A' always requires a direct passageway, generally through the middle of the conservatory to the garden.

Single doors and patio doors should always be considered. Single doors tend to be more reliable than french doors, especially if the conservatory door becomes the main route into the garden (they are much easier to toe and heel). They are also a logical choice for very small conservatories with a limited floor space.

Patio doors take up no space as they slide across themselves. Patio doors are probably not as suitable as a single or french door if they become the main thoroughfare from house to garden.

If the proposed conservatory needs a path or patio area constructing, then a useful tip when butting flags up to a dwarf wall, allow a 150mm gap and infill the gap with chippings to act as a soakaway for cill water run-off.

# DESIGNING THE FRAMES

## Designing the frames

The internal frame dimensions (including corner post or baypole) can be calculated from the external base dimensions using the deductions in the table below.

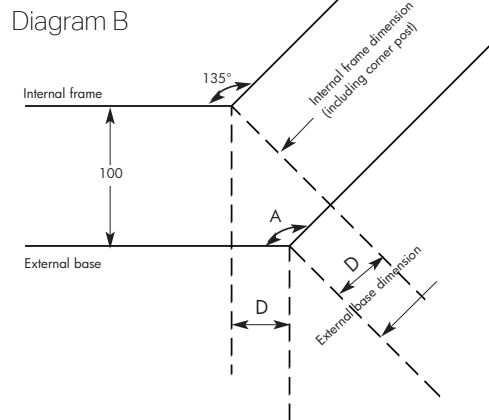
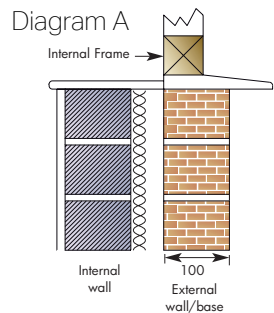

CORNER DEDUCTION - External base to internal frame							
ANGLE A	DEDUCT D	ANGLE A	DEDUCT D	ANGLE A	DEDUCT D	ANGLE A	DEDUCT D
90	100	113	66	136	40	159	18
91	98	114	65	137	39	160	18
92	97	115	64	138	38	161	17
93	95	116	62	139	37	162	16
94	93	117	61	140	36	163	15
95	92	118	60	141	35	164	14
96	90	119	59	142	34	165	13
97	88	120	58	143	33	166	12
98	87	121	57	144	32	167	11
99	85	122	55	145	31	168	10
100	84	123	54	146	31	169	10
101	82	124	53	147	30	170	9
102	81	125	52	148	29	171	8
103	79	126	51	149	28	172	7
104	78	127	50	150	27	173	6
105	77	128	49	151	26	174	5
106	75	129	48	152	25	175	4
107	74	130	47	153	24	176	3
108	73	131	46	154	23	177	3
109	71	132	44	155	22	178	2
110	70	133	43	156	21	179	1
111	69	134	42	157	20	180	05 c
112	67	135	41	158	19		

It is important to note that these deductions depend on the frames being positioned on the brickwork as shown in the diagram A i.e: the internal face of the frames are in line with the internal face of the outer leaf of brickwork (100mm in from the outer face).

From the external base dimension the above deduction D is taken depending on the corner angle A to arrive at the internal frame dimension (see diagram B).

Example below shows the frame sizes calculated from the external base sizes (41mm deduction from each corner). Remember this is the internal frame line. To calculate the actual frame sizes you will have to deduct for corner posts or baypole, whichever you are specifying.

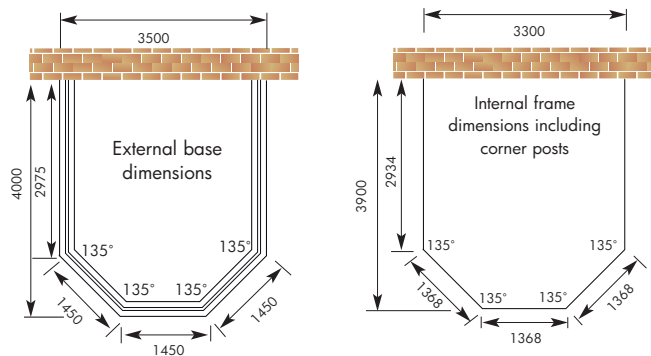

# DESIGNING THE FRAMES

## Internal facet sizes

After determining the overall external width and projection of the conservatory, the following formulae may be used to calculate the internal facet sizes:-

### 3 Facet Victorian

$$X = W \div 2.4142$$

$$Y = X \div 1.4142$$

$$Z = P - Y$$

(assuming equal facets and all angles 135°)

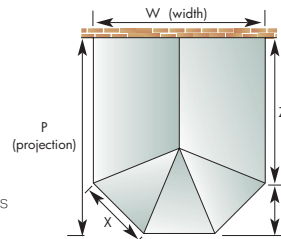

### 5 Facet Victorian

$$X = W \div 3.733$$

$$Y = W \div 2.734$$

$$Z = P - Y$$

(assuming equal facets and all angles 150°)

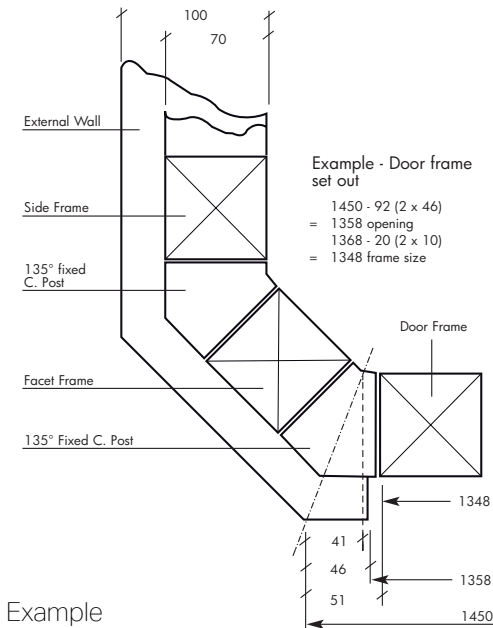
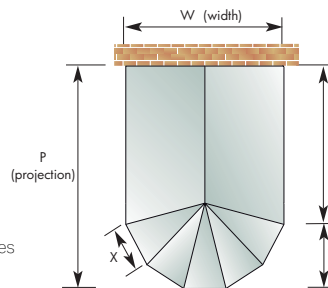

### Example

External Base Facet Size = 1450mm  
 External Base Front Facet Return = 46mm  
 External Base Front Facet Opening Width 1358mm  
 Door Actual Size = External Facet Size 1450 - 82 (2x41) = 1368mm  
 1368 - 20 (2 x 10 Cornerpost Deduction) = 1348mm.  
 Door Set Out: as shown on page 8 (example A)  
 Base Plan: as shown on page 9  
 Internal Frame: as shown on page 9

### Corner post to suit 135° & 150°

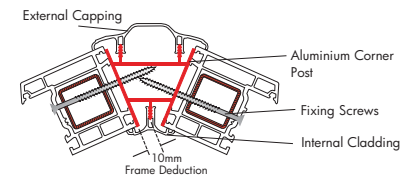

### Frame stiffener

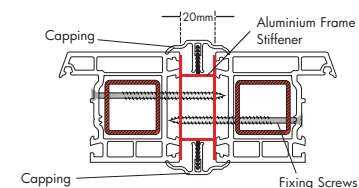

### Diagram A

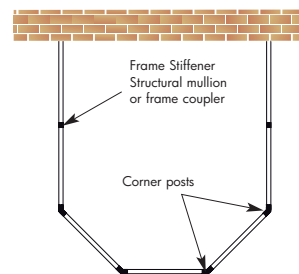

Diagram A illustrates internal frame sizes required when ordering an Victorian roof

## DESIGNING THE ROOF

### Designing the roof

This is where all conservatory designs should begin, from the roof down, top to bottom. There are occasions when either the conservatory is being built on an existing base or the base has to be in a particular position, otherwise design from the top down. The roof should be treated as a separate structure, although Wendland and its fabricators have to be flexible in that they can (in most cases) design the roof bar spacings to line through with the mullions in the conservatory wall frames - for aesthetic reasons the customer may expect this. How often has the PVCu cill been fabricated to suit the already built base (even when the base angles are inaccurate) then frames are manufactured to suit the cill then the roof fabricated to suit the frames? Wherever possible the roof design dictates the frame sizes, which decides the cill size, which determines the base size.

### The Glass Roof System

The following sections illustrate options and dimensional information for the surveyor. For snow and wind loads applicable to particular locations please refer to 'The UK Structural Design Guide' inside the VS Software.

Diagram B

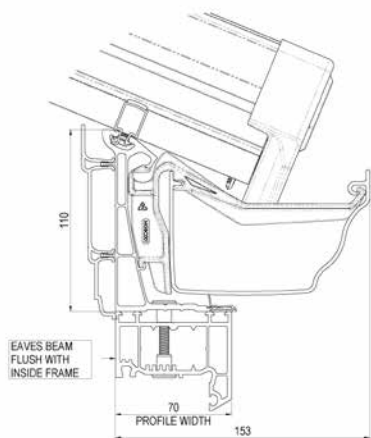

Multi Eaves Beam dimensions

Variable pitch from 15 - 35°. For greater or lower pitches use glazing bar packers (see diagram C)

### Eaves Beam - MULTI - STANDARD

When specifying the glass roof, the dimensions required are internal frame dimensions from point to point including any corner posts, bay-pole, structural mullions or jointing couplers that may have been used between the frames. See diagram B for multi Eaves Beam, see diagram C for standard and super duty eaves beam dimensions. See page 26 - 27 for more information.

Diagram C

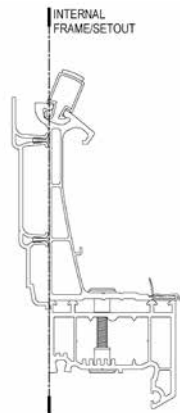

Standard Eaves Beam - illustrated with Wendland's recommended means of installation, the vic fixing kit (supplied)

## DESIGNING THE ROOF

### Gutter Outlet

#### Option 1.

On survey check that the salesperson has agreed with the customer where they wish the conservatory roof to discharge from and drain to before designing the frames. Available L/H or R/H is the standard option supplied unless any other option is specified. The rainwater pipe is dropped down the house wall, kept clear of any opening vents in the side of the conservatory. LH is RS7063 - RH is RS7064.

#### Option 2.

L/H is RS7076 - R/H is RS7077 keeps the rainwater pipe tight into the corner. However, consideration should be made for packing the frames away from the wall so that the pipe is clear of the glass line or opening vents.

#### Option 3.

RS7076 running outlet can be used in any position. However, consideration should be made for the rainwater pipe (65mm wide) when designing the frames to keep it clear of the glass line or opening vents.

#### Option 4.

Drill and fix outlet. Can be fixed in any position - requires only 40mm outlet pipe - RS7053. Recommended only as a last resort as limited outlet can easily be blocked by debris, leaves etc.

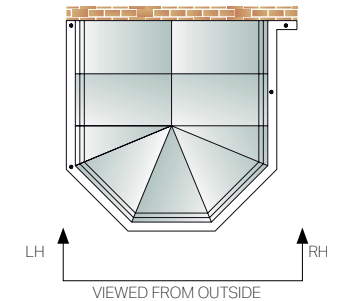

### Dentil Moulding - optional

When specifying dentil moulding, allow 25mm for the dentil add-on section. Alternatively the dentil can be supplied without the back legs and add-on section if your frame is deep enough to accommodate the dentil fitted directly (with adhesive).

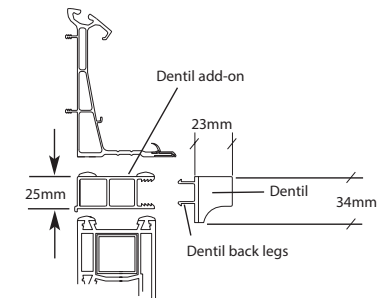

### Box Gutter

When specifying a box gutter this is indicated on the roof plan as diagram A).

The standard box gutter is 165mm wide (for use when collecting from a single roof). The 265mm wide box gutter is used to give extra capacity when collecting from two roofs eg. bungalow situations etc. The reinforced box gutter that enables a 6M span and reduces the need for gallows brackets on bungalows.

Diagram A

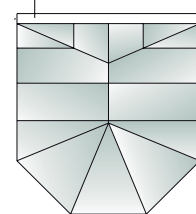
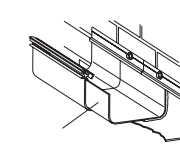

Diagram B



Jointing Sleeve

Special box gutters such as 'L' shape, 'U' shape, raised back or elevated are available to order. Large box gutters may have a mechanical joint to aid transportation as diagram B - jointing sleeve).

It is advisable to support such box gutters under the joint with a gallows bracket, pole (ie. a corner post) or brick pier. Always indicate the preferred position of joint so that any bracket does not foul with patio doors or windows.

### Extruded Box gutters

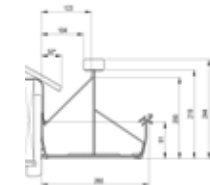
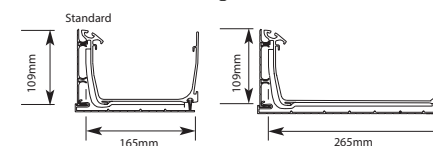



## DESIGNING THE ROOF

### Box gutter situation to AVOID (if possible) & cost effective solution

Diagram D) shows the dwarf wall built off the corner of a projecting part of the building. The resulting roof requires a special "raised back" 'L' shape box gutter. This is more expensive, takes longer to install and is unsightly. **Diagram E) shows a more cost effective way for this situation which requires a standard box gutter.**

The box gutter is connected to the standard guttering around the conservatory with a box gutter adaptor. There is a range of 14 adaptors with or without outlets. Box gutters are available with an outlet welded into the box gutter itself. This option should be clearly indicated on the roof plan with the exact position of the outlet required.

Building a 65mm offset into the dwarf wall allows a standard 165mm box gutter to be used. When the conservatory comes off the projecting building at 135°, an offset is still used but the dimension on the face brickwork changes to 123mm. (See diagram F) If 150° the offset is 108mm (See diagram G)

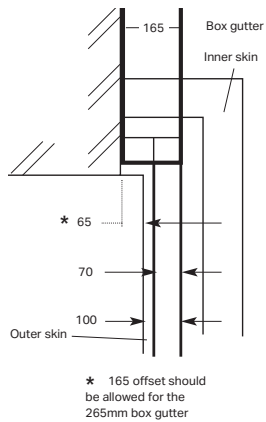

Diagram D

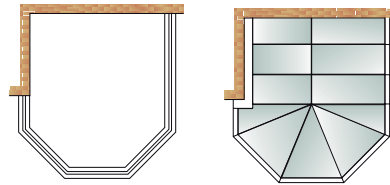

Diagram E

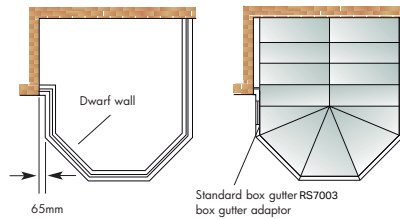

Diagram F

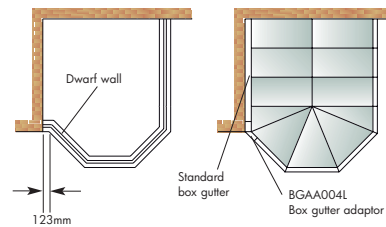
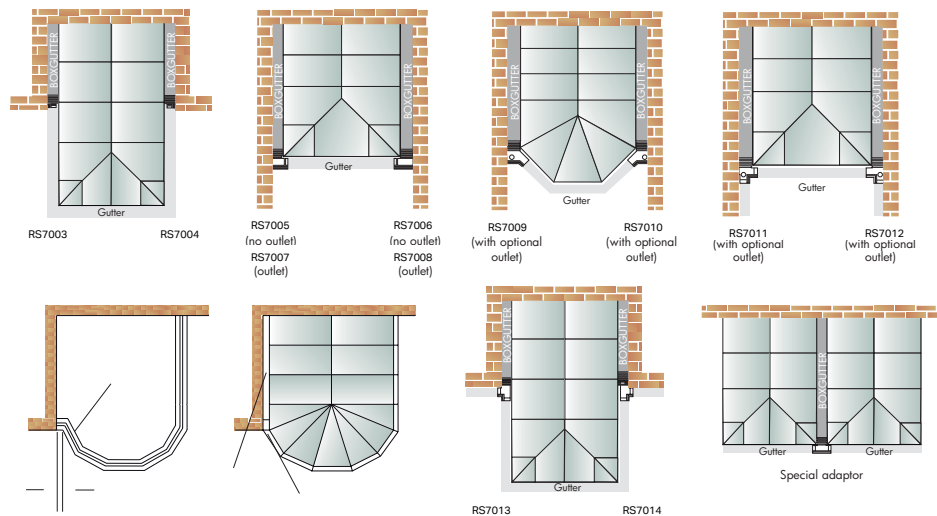

Diagram G



## BOX GUTTER SUPPORT

**ALL box gutters (especially those with tie bars or joints) MUST be supported.**

**Wendland recommends several types of support for box gutters including brick piers. Fitting a conservatory box gutter without adequate support will lead to structural failure. Please take the correct steps BEFORE installation.**

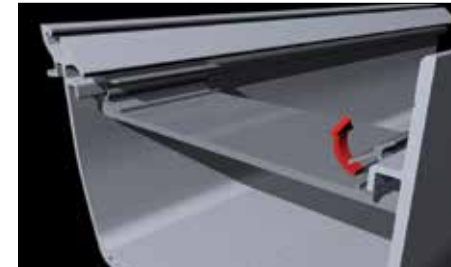

### Box Gutter Strap

#### 165mm box gutters

These are supplied loose and **MUST BE FITTED** – they are a structural requirement of the roof. The straps must be installed within 75mm of glazing bar centres (when measured from centre of the strap to the centre of the bar). To install these straps, simply 'nip up' as shown.

#### 265mm/special box gutters

Straps are factory welded into position.



### Box Gutter Hanger

#### 165mm box gutters

If these have been specified by your company at the time of order they are supplied loose and must be fitted.

**The structural requirement for the hanging brackets are 2 x hanging brackets (sat side by side) at a maximum span of 2300mm unless the roof has a tie bar or joint on the box gutter which should then be positioned in the same area.**

Drill through the head of the hanger into the centre of the masonry, avoiding the mortar joint if possible. Use a masonry anchor suitable for the substrate. Lead flashing should be dressed down over the hanger, and snipped around the sloped leg. To attach it to the box gutter, simply 'nip up' as shown.

#### 265mm box gutters

Hanger not available.

### Gallows Bracket

These are available for 165/265 box gutters.

To install, notch out the insulation to ensure metal to metal contact between the extruded box gutter and gallows bracket. Offer up the gallows bracket and mark it ready to drill – always try to line up with the centre of a brick rather than a mortar joint. Drill the gallows bracket (the positions should be similar to the ones shown). Three masonry anchors should be used that are appropriate to the substrate.

Finally, notch out the undercladding, offer it into position and clip in.

**Maximum centres are 2300mm. If the roof has a tie bar installed or a joint within the box gutter, then a gallows a gallows bracket should be installed directly underneath it.**



## USE OF BOLSTERED GALLOW'S BRACKET

There are three types of Bolstered Gallows Bracket, and these are all used where there is a raised back box gutter.

### Hip

Hip bars (without a tie bar at final point) are under compression (at the bottom they are pushing on the box gutter) When the box gutter is raised back the hip bar does not strike through the corner but sits on top of the plate. The plate is not strong enough to support this load, so the Bolstered gallows bracket is used and the hip bar is fixed to the top of it with 4 No M6 bolts

### Transom Tie Bar Support

Where a Tie Bar hits a raised back box gutter; the plate on the box gutter requires support. Transom bars connected by tie bars act as a truss and produce a concentrated point load at their location. Occasionally we can use two hanging brackets, but predominantly we use bolstered gallows brackets to support this load. Please note where the tie bar is more than a quarter way up the glazing bar; the tie bar bracket has to be fixed to the gallows bracket and not the glazing bar.

### Beam Tie Bar support

Is it not always possible to place a bolstered gallows bracket directly under the transom tie bar, due to window/door openings. Where this occurs two gallows brackets are placed either side of the opening and a beam is joined to the top of these brackets. This beam distributes the concentrated load (from the tie bar) to these gallows brackets. This design is sometimes used on box gutters that rise above 500mm, to provide support to the plate.

Custom designed gallows brackets are sometimes required



## CONSERVAFLASH

**Conservaflash is a pre-formed PVCu flashing system that will change the way you install.**

Conservaflash is an engineered product offering professional results - in a flash! Conservaflash can be specified when a roof is ordered and a pre-configured flashing pack will be delivered with the roof. Conservaflash can be specified when the host wall is of brick construction.

- Stepped Flashing for 15°, 20°, 25°, 30° and 35°.
- Straight Flashing option for lean-tos.
- Save money when compared to buying lead.
- Save at least an hour on each installation.
- No waste - precise amount supplied.
- Comes with the roof - an integrated solution.
- Convenient, pre-packed with no environmental risks.
- Suitable for duo pitch and lean to 'gable to gable' designs

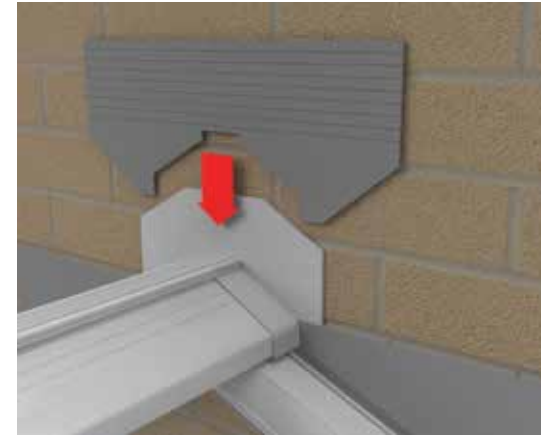

Fit RS4478

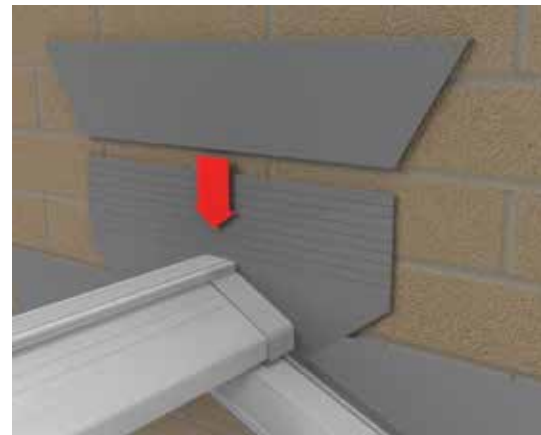

Fit RS7153

# DESIGNING THE ROOF

## Ridge

When a roof height is specified on an quotation or confirmation, this is measured from the underside of the eaves beam (top of your window frames) to the top of the ridge capping (excluding crests and flashing trim) as diagram B).

Unless otherwise stated, the standard roof pitch is 25°. However, Victorian roofs can be manufactured from 15° to 40° in 5° increments if required.

When calculating a roof height where a height restriction exists, allow 50mm for the flashing trim (diagram C) and sufficient room for the flashing itself, 100mm min.

The crestings and finials are higher than the flashing trim (see diagram D), but this is not normally critical when considering the height of the roof. Note: Be aware of outward opening windows above, especially side hung.

Diagram B

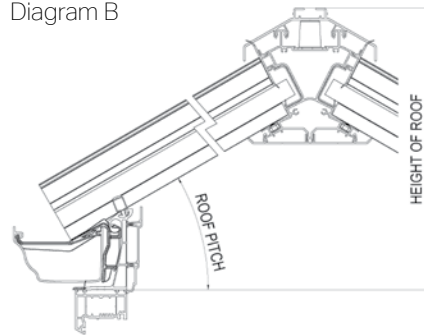

Diagram C - Flashing Trim

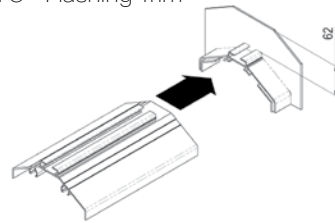
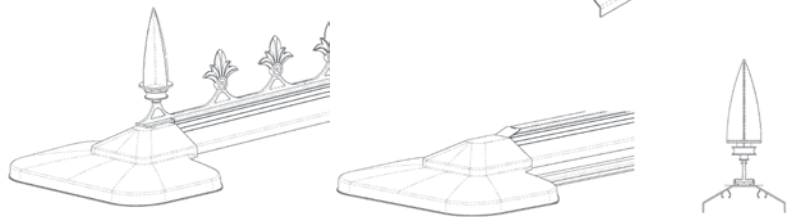
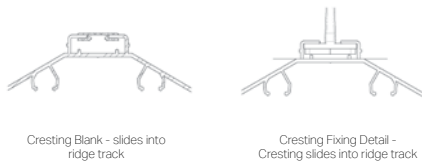

Diagram D - PVC Crestings and Finials



## Technical Specification



## Half Ridge Crown Cap

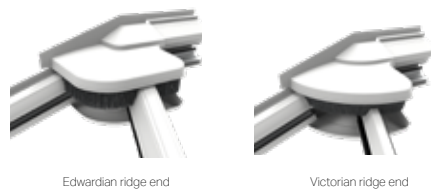

# DESIGNING THE ROOF

## Ridge Length Calculations

When a ridge length is specified this is measured from the end of the ridge nearest the wall to the finial point, or from finial point to finial point in the case of a double ended ridge. It is not normally necessary to state the ridge length when ordering a complete roof as we will calculate this. It is Wendland's policy to make the ridge length so that the pitch of the roof is equal on all facets wherever possible as in diagram E).

Diagram E

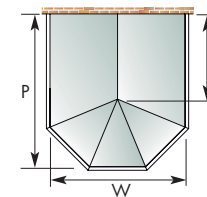

$$L = P \cdot \frac{1}{2}W$$

Diagram F

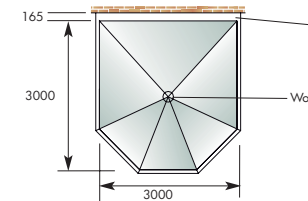

RIDGE LENGTH = ZERO

Diagram G

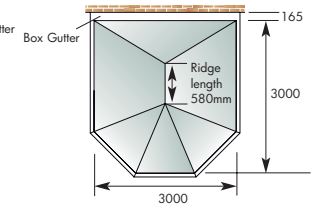

In the case of a double ended roof as in diagram F) the theoretical ridge length may be zero or even a negative number. This is when normally a 'wok' would be used instead of a ridge. However, if a ridge is preferred this should be specified.

The ideal minimum double ended ridge is 580mm (this allows one complete length of cresting between the finials). It should be noted that when a ridge is made longer than its theoretical length, then the pitch will be greater on one or both of the radius ends than on the sides, as per diagram G).

## In line ridge to half ridge setting out

**When surveying/setting out for this on a similar style of conservatory the following detail should be considered where the ridge joins the half ridge.**

In order for the internal claddings and external cappings to line up, the centre line of the main ridge should be 32mm off the corner of the building (diagram B). Therefore, when setting out the base and dwarf walls, this offset should be included in the base dimensions (diagram C).

Diagram A

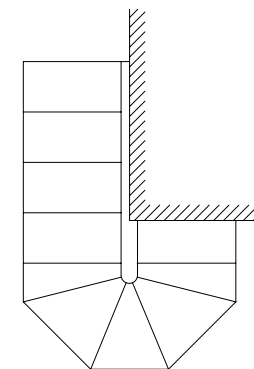

Diagram B

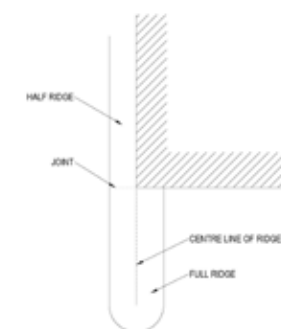
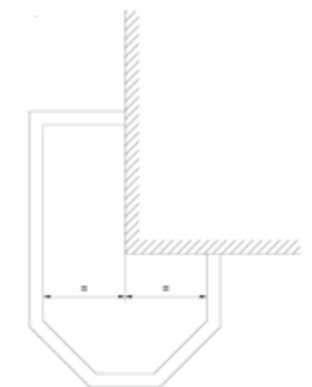
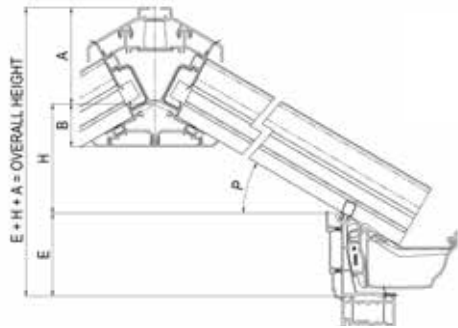

Diagram C



## DESIGNING THE ROOF

### Ridge Height Calculation



RIDGE HEIGHT CALCULATION			
P= PITCH	DIMEN- SION A	E= EAVES HEIGHT	DIMEN- SION B
15	143	109	41
20	138	109	46
25	133	109	51
30	128	109	57
35	121	109	63
40	114	109	70

$$\text{OVERALL HEIGHT} = E + 1/2 \text{ INTERNAL WIDTH} \times \text{TAN } P + A$$

\*ADD 50MM RIDGE FLASHING TRIM

### Half Ridge Height Calculation

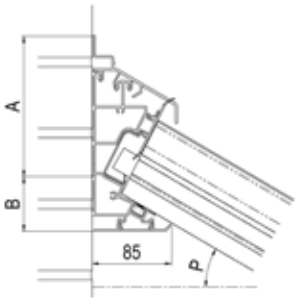

HALF RIDGE HEIGHT CALCULATION			
P=PITCH	DIMEN- SION A	E= EAVES HEIGHT	DIMEN- SION B
5°	174	109	32
10°	170	109	37
15°	165	109	42
20°	160	109	47
25°	155	109	52
30°	149	109	58

$$\text{EAVES HEIGHT} + \text{INTERNAL PROJECTION} \times \text{TAN } P + \text{DIM A} = \text{OVERALL HEIGHT}$$

### Lean-to Wallplate Calculation

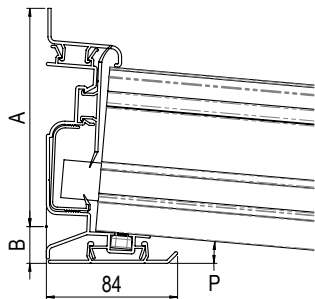

LEAN-TO WALL PLATE CALCULATION			
P=PITCH	DIMEN- SION A	E= EAVES HEIGHT	DIMEN- SION B
2.5°	140	109	21
5°	138	109	23

$$\text{EAVES HEIGHT} + \text{INTERNAL PROJECTION} \times \text{TAN } P + \text{DIM A} = \text{OVERALL HEIGHT}$$

## DESIGNING THE ROOF

### Valley

Where the valley meets the eaves beam, the angle between the eaves beam sections should be 90° as shown in diagram A). The situation as shown in diagram B) should be avoided especially with glass roofs:-

Diagram A

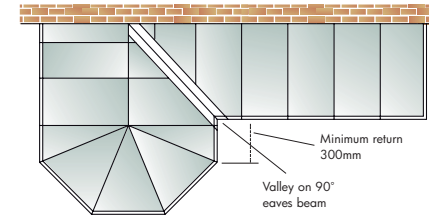
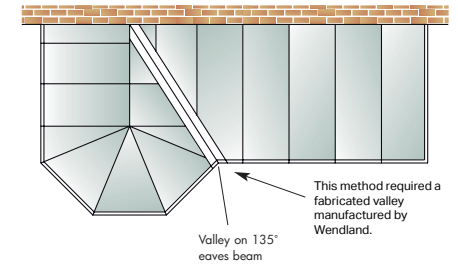

Diagram B



### Structural action of tie bars.

Requirements for tie bars within a conservatory are dependent on several factors such as size, pitch, configuration, glazing and locality. The installation of a tie bar will limit this movement.

The ridge is propped by the glazing bars. This vertical load is transferred along the axis of the glazing bar and is known as an axial load.

The axial load is transferred to the eaves beam where it is useful to convert it into vertical and horizontal loads for simplicity. Using a tie bar, to tie together the glazing bars pulling in opposite directions, resists the horizontal load. Hence canceling out the horizontal loads.

This leaves the vertical load to be taken care of. It is recommended to situate the window frame mullions beneath the tie bars. Allowing the vertical load to be safely and directly transmitted to the dwarf wall and foundation. The eaves beam has been designed to span between mullions in cases where the glazing bars have not been lined up with the window mullions beneath.

It is also strongly recommended that tie bars are not positioned over opening double doors, as this will cause the eaves beam to deflect downwards. This will result in tie bar not being able to support the ridge at its correct level and therefore the ridge will deflect downwards by a similar amount. Depending on the weight and span of the roof, the span of the ridge (between tie bars or other vertical support such as existing walls) and position of a tie bar over double doors, the eaves beam will show noticeable deflection and snagging or jamming of the doors beneath.

In the case of Gable, or Duo pitch conservatories a Tie bar **must always** be positioned on the first glazing bar back. As the Gable frame is of a un-quantified strength and that given the fact that there is no direct connection between the frame and ridge section (other than a single bolt from the starter bar / end bar) the Tie bar on the immediate bar back minimizes any loads imparted on the gable frame and helps combat any deflection along the ridge length.

All tie bars recommended must be fitted prior to glazing (polycarbonate and glass). Failure to install tie bars or position them other than specified will compromise the structural integrity of the roof

# DESIGNING THE ROOF

## Glazing Bar Spacing

When ordering the roof, it is not necessary to state the exact glazing bar spacing unless you are attempting to line up the glazing bars with the mullions of the frames below. When considering the glazing bar spacings, Wendland will attempt to space the bars equally wherever possible. It is generally accepted that equal spacings look aesthetically better even when the bars may not line up with the frames below.

## Glazing Options

Another consideration when designing the glazing bar layout is Jack Rafters versus Splayed Bars. Sometimes the overall dimensions of the roof will create the need for staggered jack rafters as in diagram A). Splayed glazing bars (as in Diagram B) may be preferred to staggered jack rafters

The Glass system will accommodate different glazing materials, ie: polycarbonate or double glazed units and different glazing thicknesses of 24, 25 and 35mm. It is important to state which material and which thickness is to be used.

When ordering a roof unglazed, it is important to state whether unglazed for polycarbonate or unglazed for glass

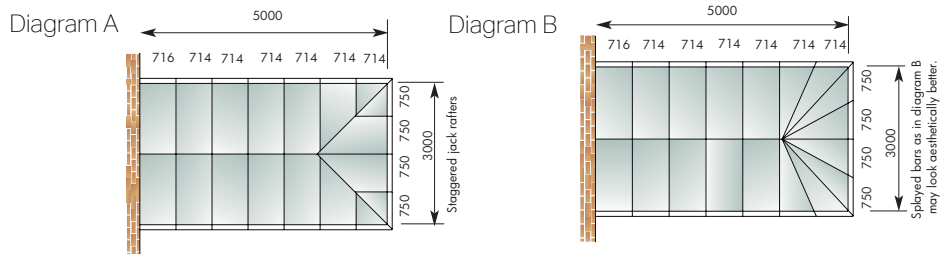

## Tie Bar

When ordering a complete roof, Wendland will determine when a tie bar is required from a structural point of view. However, sometimes customers request a tie bar from an aesthetics point of view. If this is the case, please state on the order. Where the tie bar and ceiling fan clash use two vertical drop rods. See Diagram 'C'.

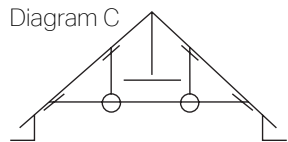

3 way T shape tie bar

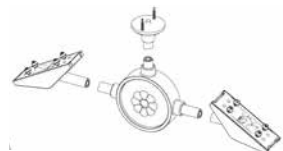

## Gable Frame

Historically, when choosing a gable style conservatory roof, the front gable window frame sat directly onto the door frames. This was always a problem in that the doors below when "slammed to" created frame wobble above, which in turn affected the roof.

The introduction of the gable support beam creates a link between the frames which increases the structural and lateral stability substantially.



With a gable front conservatory the aluminium ridge body is cut to sit on top of the gable frame (supplied by you) so that the ridge body and external ridge capping finish flush with the external face of the frame. The internal ridge undercladding finishes flush with the internal face of the gable frame.

(See illus and dimensions opposite) to allow you to fabricate your gable frame prior to receiving your glass roof.

With a gable frame situation the end glazing bar (starter bar) fits directly onto the frame as shown.

Note: The firing top cap must be installed on top of the gable frame prior to fixing to the starter bar.

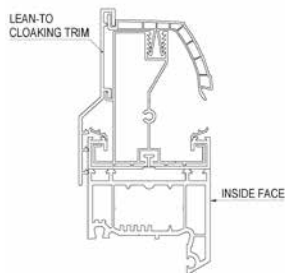

# EAVES BEAM MEASUREMENTS

## Standard Eaves Beam

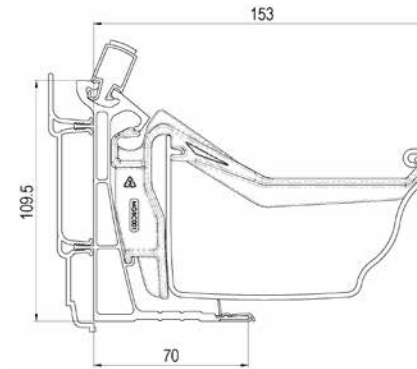

## GABLE BEAM

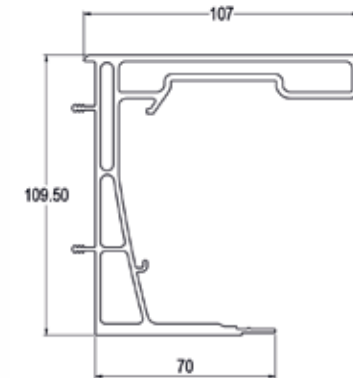

## CORNICE MEASUREMENTS - Standard Eaves Beam

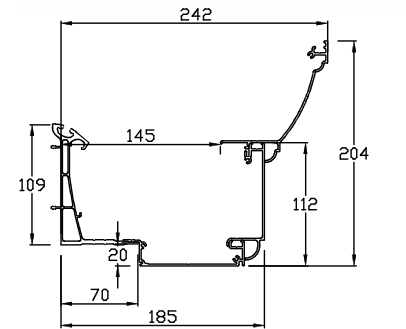

## BOX GUTTERS MEASUREMENTS

165mm

265mm

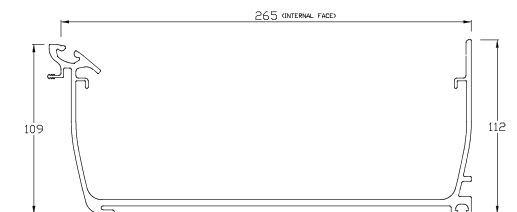
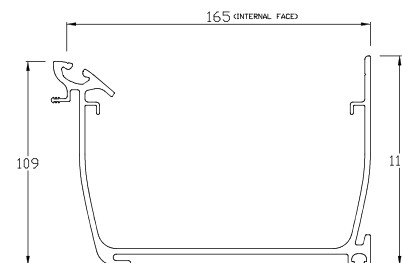

## REINFORCED BOX GUTTERS MEASUREMENTS

- A factory insulated reinforced box gutter that enables a 6M span with 265mm box gutter
- Must be supported either end by hupl, brick wall, or aluminium post \*
- Reduces / eliminates the need for gallows brackets on bungalows
- Breaks in the I beam allow for water flow and fixing access & point at the image
- The maximum length of box gutter is 6m, to suit internal frame size of 5860mm.
- The box gutter can be jointed every 5.8m. Joints must be supported at each location and specified when ordering
- Whole assembly will be pre-welded
- Can be used on all Glass Roof and Livinroof

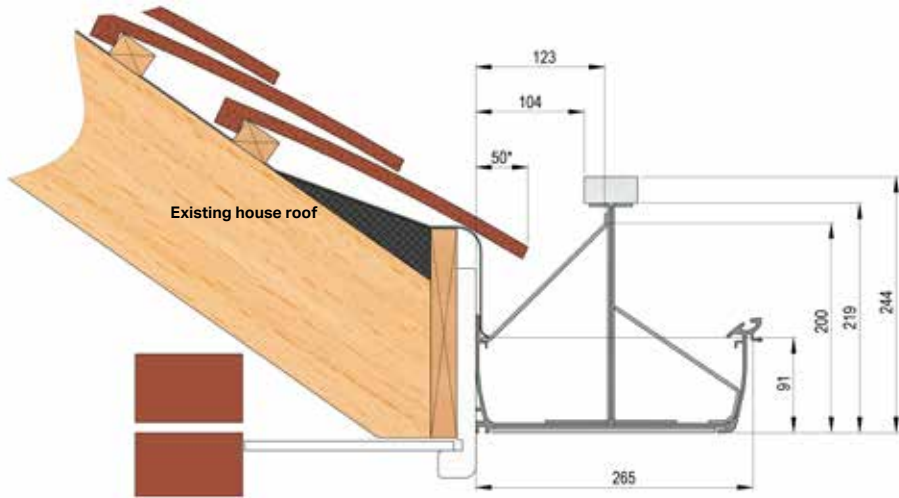

### Key Surveying Information

- Boxgutter weight is approximately 13kg/m. A 6000mm long boxgutter will weigh approximately 78kg. A genie lift or other handling equipment may be required.
- \*50mm minimum overhang requirement for roofing tiles into gutter.
- Ensure that roof tiles will not foul on boxgutter reinforcement.
- If tile overhang is greater than 50mm and fouls on boxgutter straps, reduce tile overhang to minimum requirement of 50mm.
- Alternatively pack away the boxgutter to accommodate the tile overhang (\*Note, roof size will require amending to suit\*).
- Ensure gutter is fully supported at ends by pier, hupl wall, or structural post.



## GALLOWS / HANGING BRACKETS MEASUREMENTS

### 165 Gallows Bracket

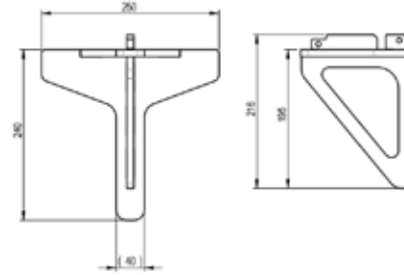

### 265 Gallows Bracket

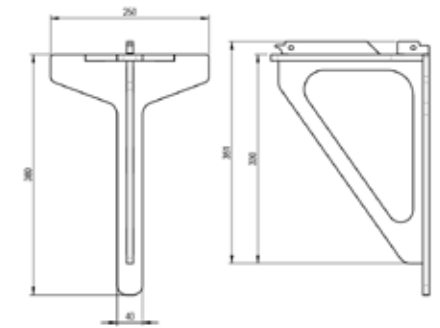

### 165 Hanging Bracket

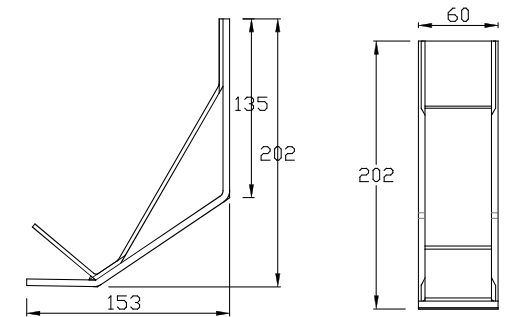

## BI FOLD SUPPORT BEAM & EAVES SUPER BOLSTER

Bi-fold support beam which mounts to the underside of the eaves. Eaves super bolster which mounts to the inside of the eaves beam.

- The bi-fold support beam and eaves super bolster profiles can be used separately to bolster the eaves or combined to further increase the spanning capability.
- The bolster sections only need to be specified on the elevation where the larger opening is required.
- The bi-fold support beam is 70mm tall and runs between corner posts.
- The eaves super bolster support beam is 134mm tall.
- PVCu claddings on internal and external fascia.

On the elevations which do not require the spanning capability, either the frame height can be adjusted, or a standard frame add on or corner post profile can be used to pack the frames under the eaves.



Standard Eaves

Bi-fold Support Beam  
70mm tall

NEW  
Eaves Super Bolster  
134mm tall

NEW  
Combined Bolstered Eaves

## CHAMBERED GLAZING BARS MEASUREMENTS

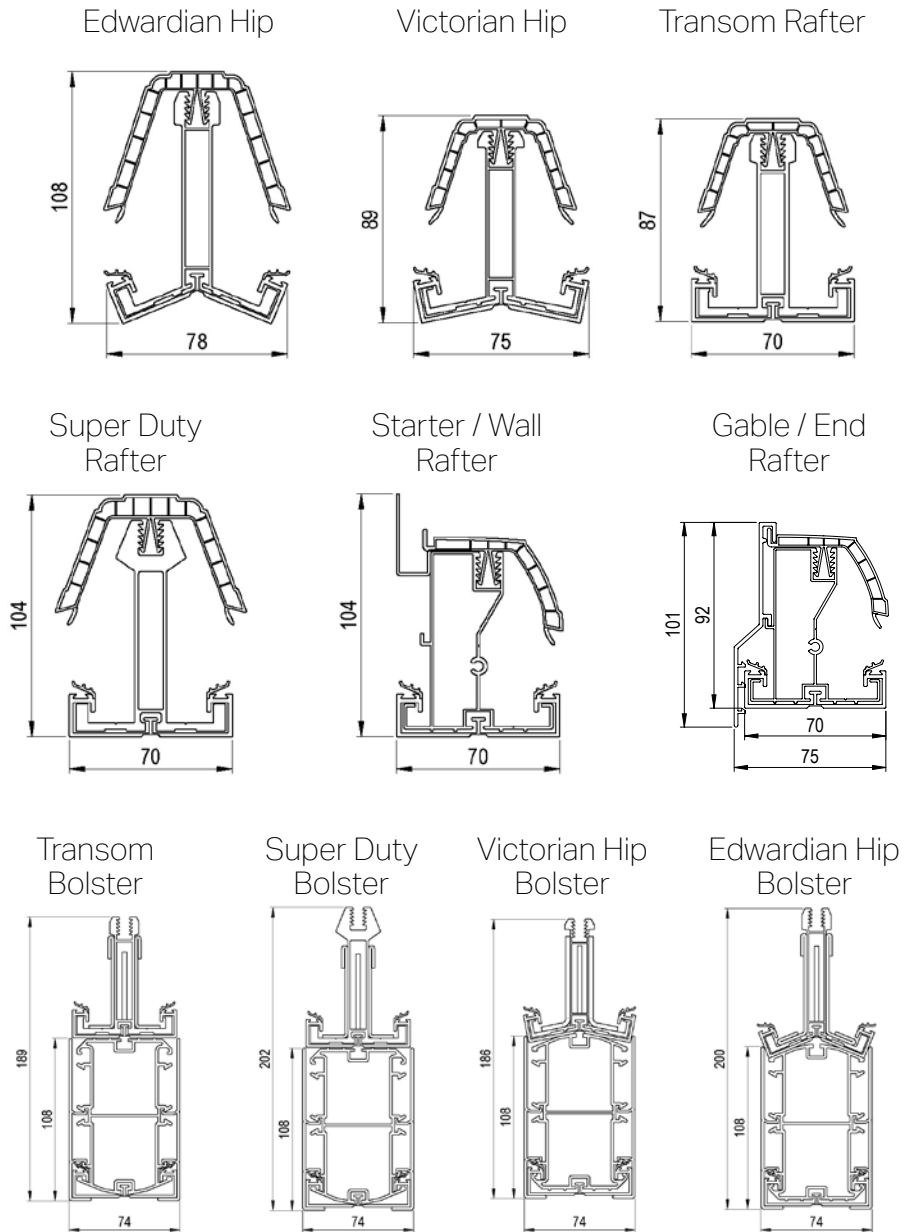

## RIDGE AND WALLPLATES MEASUREMENTS

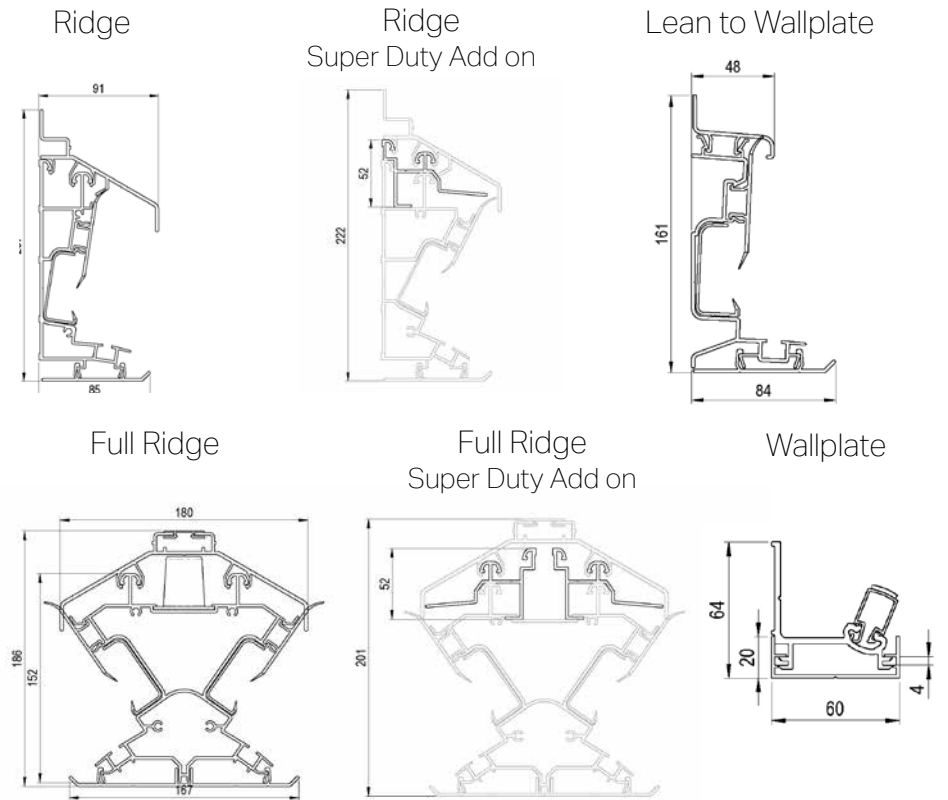

## FINIALS & CRESTINGS MEASUREMENTS

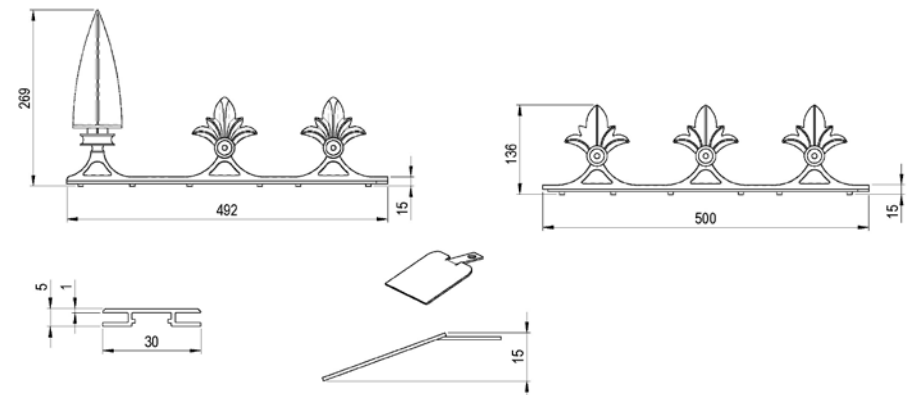

165MM BOX GUTTER ADAPTORS

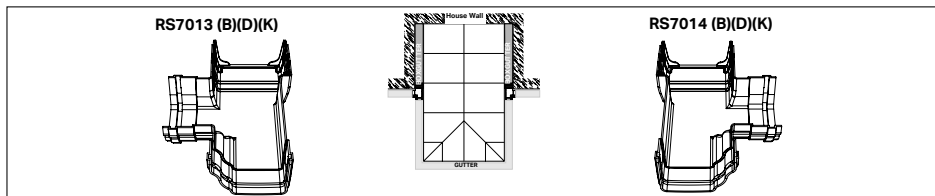
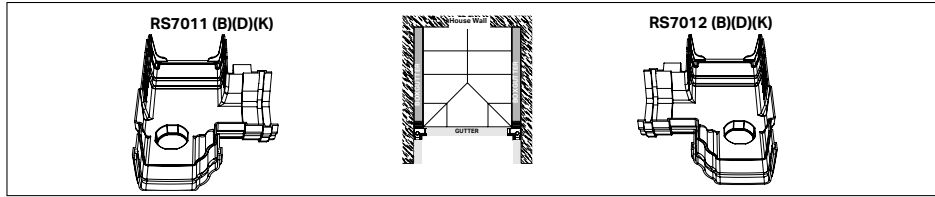
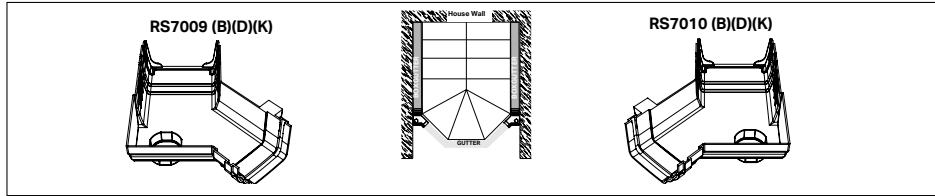
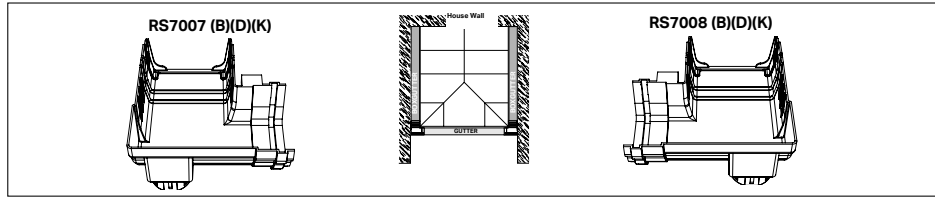
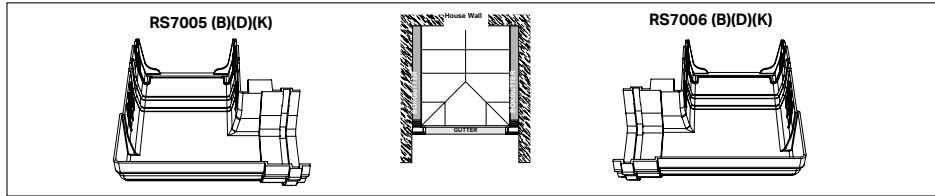
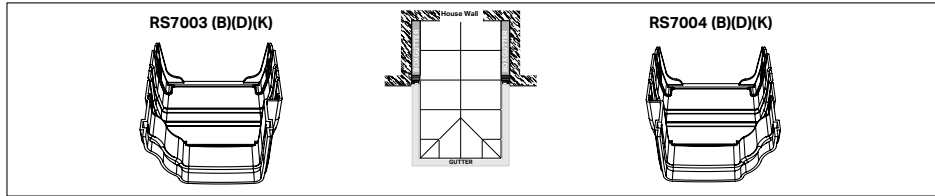

265MM BOX GUTTER ADAPTORS

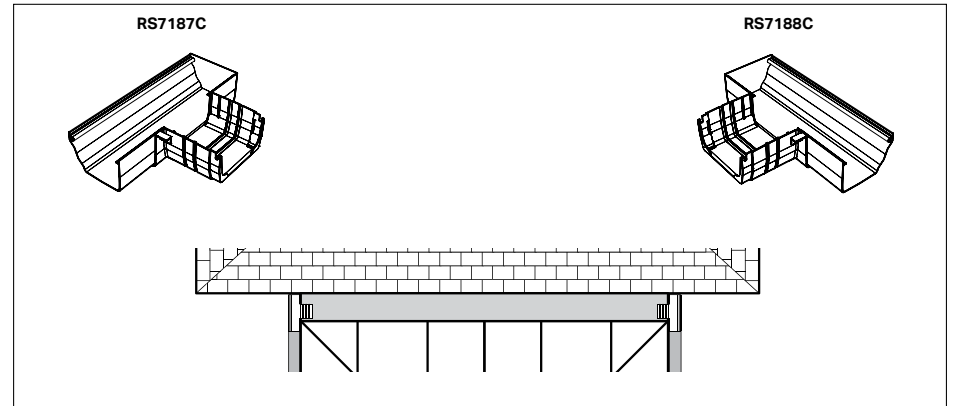
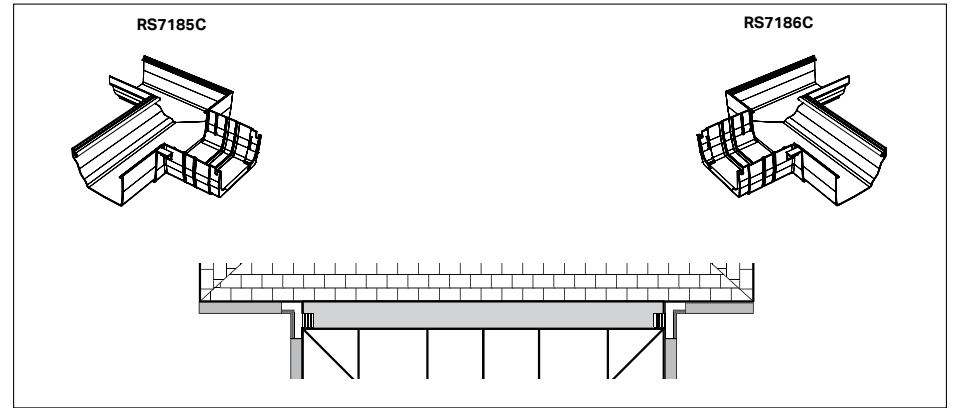
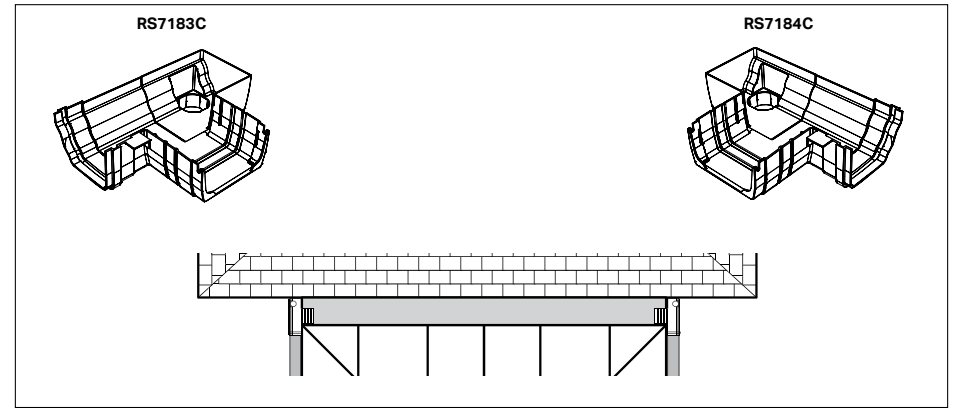



**LEFT HAND**

**RIGHT HAND**

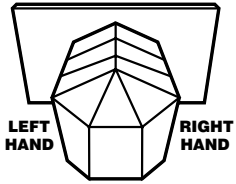
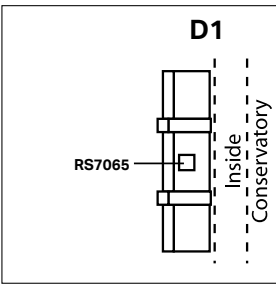
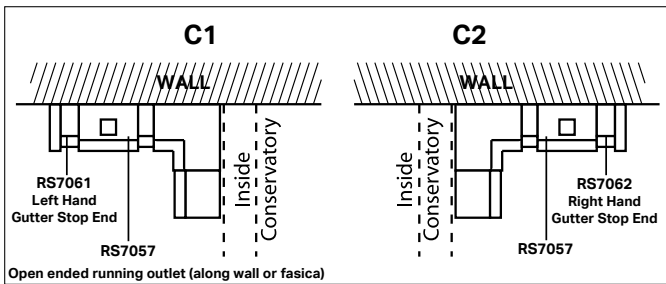
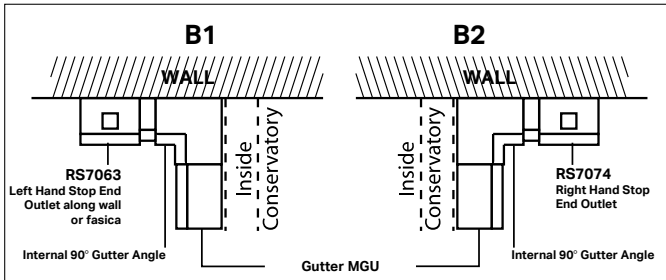
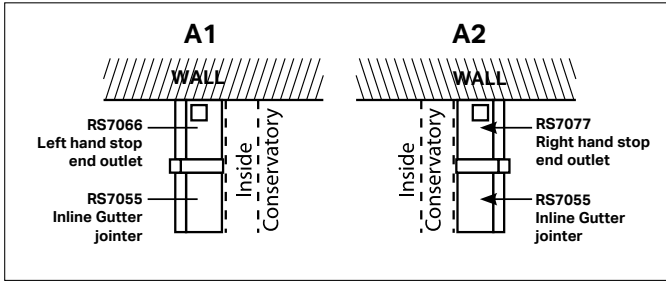

REMEMBER- MARLEY GUTTER IS 'HANDED'

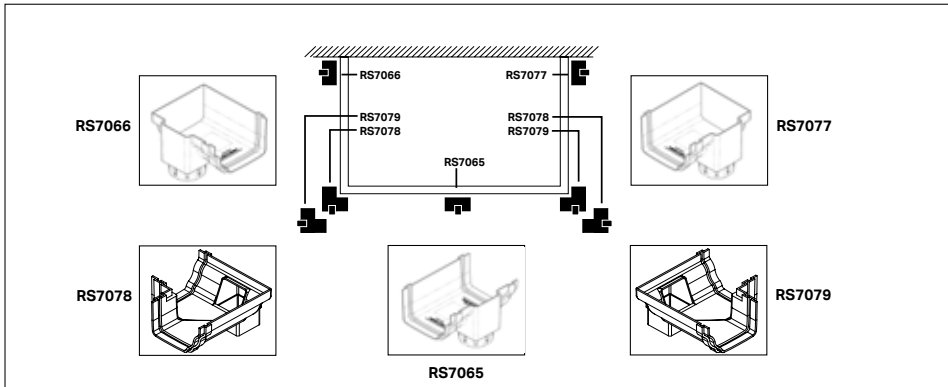



[www.Wendland.uk.com](http://www.Wendland.uk.com)

© Wendland - Our policy is one of continuous improvement and we reserve the right to change specification and design at any time without prior notice

Job No. 6095 WENDLAND Tech V4 08/24