



V15 | August 2024

SOLID ROOF SYSTEM OVERVIEW GUIDE

DEAR TRADE PARTNER OR CONSERVATORY BUYER,

Based on the Classic glazed roof technology it's familiarity to surveyors and fitters is one of its main strengths. Livinroof is a cost effective, simple to fit pre-packaged solid roof kit that is aimed at the replacement of tired conservatory roofs

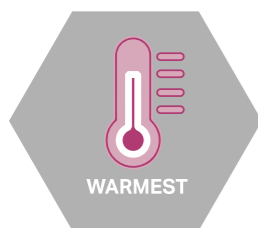

WARMEST

Unrivalled thermal performance

- A true warm roof system with no cold bridging.
- U-Value of 0.15 with the option to reduce to 0.12
- **Thermally insulated** internal pelmet as standard.
- **Thermally broken** rafters.



LIGHTEST

The lightest solid roof on the market

- Weighs only 31kg/m² **lighter than any other solid roof.**
- Designed by conservatory specialists, Ultraframe to **replace existing conservatory roofs.**
- **Lightweight panels** are cut to size and easy to manoeuvre.



VERSATILE

The most configurable solid roofing system available

- Ideal for solid replacement solution for low pitched lean-tos with **pitches from 5 to 40.9°.**
- Advanced software to instantly validate structural requirements of **any complex designs.**
- **Shaped glazing** inserted anywhere in the roof at no extra cost.



FIRE TESTED

Independently and fully fire tested

- The complete, assembled Livinroof structure was **fire tested in 2017** by Warringtonfire.
- Livinroof is **fire rated as B-roof** according to EN 13501-5: 2016.
- Livinroof aluminium panel is **fire rated as AA** according to BS476-3:2004.



SAFEST

The only solid roof engineered to postcode

- NASA satellite data used to **precision engineer every roof** for Wind AND snow loads.
- Wind tested to withstand to hurricane winds up to 130mph.
- Independently fire tested BS476 part 3.
- **Super strong** eaves beam, ridge, valley and jack rafter.



BRIGHTEST

More glazing options than any other solid roof

- **Shaped glazing** for a bespoke and stunning internal design.
- **Highly configurable** glazed panels for natural light where needed.
- Performance glass easily integrated **at no extra cost.**



Livinroof is a cost effective, simple to fit pre-packaged solid roof kit that is aimed at the replacement of tired conservatory roofs.

Based on the glazed roof technology it's familiarity to surveyors and fitters is one of its main strengths.

Livinroof substantially overcomes – for the consumer – the twin issues of the conservatory being too hot in summer and too cold in winter. Moreover, it creates a beautiful vaulted plastered ceiling inside and with a stepped detail at the eaves using the insulated internal pelmet system, the perfect place for cables and spotlights.

For those consumers who still want an element of light through their new solid roof, the clever configurable technology allows the fitment of multiple glass panels – this can be a major consideration for the adjacent room that the consumer needs to consider.

Please read this document carefully along with the Classic Roof Surveyors Guide to ensure you are familiar with Livinroof specification.

For assistance with Livinroof design/specification please contact the Technical Support team on 01200 452918 or techsupport@ultraframe.co.uk

Using this System Overview & Design Guide

Reading this guide early in the design/quotation process may save time later and more importantly the consumer may not have the budget to proceed. Careful pre-sales survey/checks can ease the process – undertaking a pilot hole dig alongside the base for example and inviting the Local Authority building inspector (or other Approved Building Control Inspectors like Stroma). You may be able to charge the consumer a 'deposit' for this inspection, redeemed if the project goes ahead.

CONTENTS

Livinroof System Overview	4
Key features and benefits	5-6
Principles of replacing glazed roofs with solid roofs	7
hup!	8
0.12 Thermal improvements	9-10
Similarities (and differences) to Classic glazed roof	
- Specification items	11
- System overview	12-15
- Panel sizes/centres	16
- Glazed panel layout guidance	17
Assessing the existing conservatory	18-21
Appendix 1 Resin Anchors	24
Appendix 2 Cavity tray assessment	24
Appendix 3 Tie bars	25
Appendix 4 Eaves beam - Super duty, Bi-fold Support Beam and Eaves Super Bolster	26
Appendix 5 Spanning Performance - System Elements	27-30

This is what you receive with Livinroof

- Classic roof in RAL7016 'matt effect'
- 90mm High Performance PU board insulation, cut to all shapes.
- 25mm High Performance PU board insulation as secondary layer.
- Black Marley Classic gutter.
- High performance sealed units

(Not supplied - resin anchors and plasterboard)

IMPORTANT - NOTE 1

The installer is responsible for ensuring that where Livinroof is supported by means such as timber frame walls, the structure provides enough lateral support and resistance to wind uplift. Further guidance can be obtained through this guide's technical documentation. Livinroof cannot be responsible for the structural adequacy of any existing building work used as part of an overall conversion. While assistance is provided, ultimate responsibility to secure Building Regulations lies with the retail installer. **IF IN DOUBT ABOUT STRUCTURAL COMPLIANCE, PLEASE CONSULT STROMA OR A STRUCTURAL ENGINEER**

IMPORTANT - NOTE 2

This guide is intended to provide indicative information and to help you understand the design principles and applicable loadings. U-Design is the final arbiter on price and specification decisions.

IMPORTANT - NOTE 3

The Livinroof components have been designed and manufactured to meet the specification of each individual job. Any significant on site modifications particularly relating to the repositioning of any structural members will invalidate the product's warranty and compromise the structures integrity. If adjustments are required due to site conditions please consult us.

OVERVIEW

Product definition

Livingroof is purpose designed for the replacement of tired glazed conservatory roofs. Externally it uses the familiar Classic roof painted in RAL7016 urban grey and glazed with insulated panels. Internally it uses two separate insulation layers (provided). At the eaves, the insulated internal pelmet engineered steelwork ladder system is used - all internal roof surfaces are then plaster boarded (see below for specification, not supplied) before being plaster skimmed.

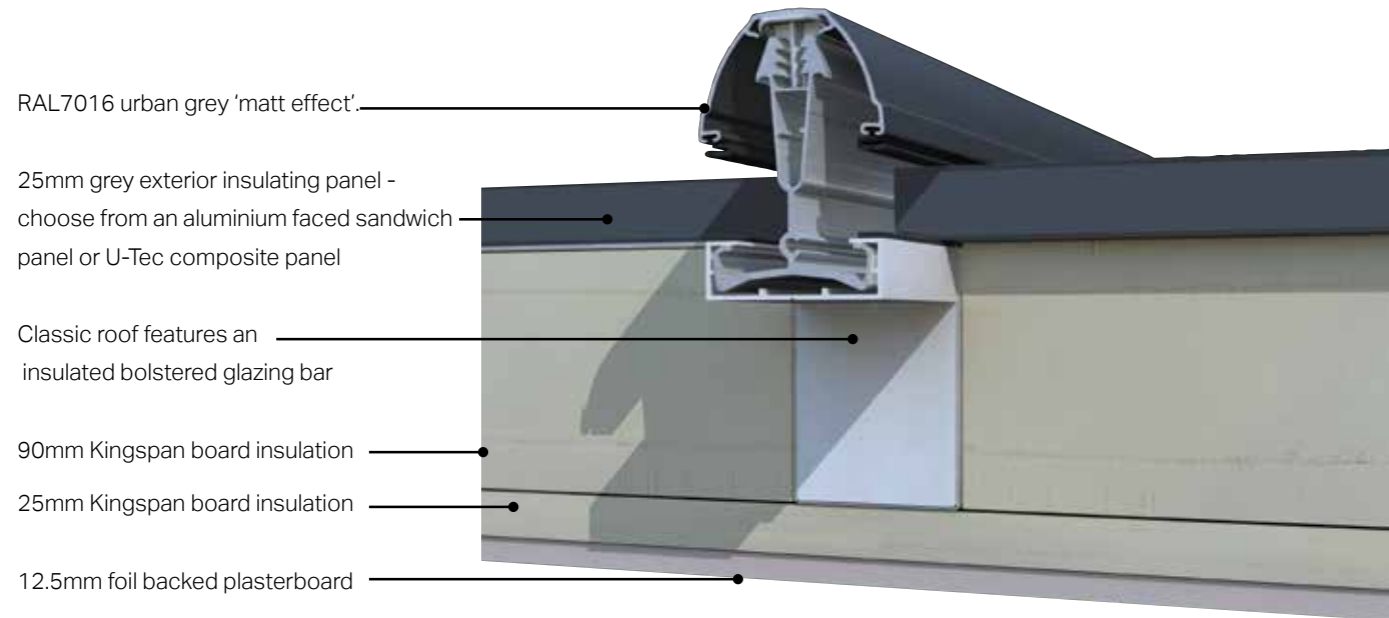

Key performance criteria

- A pre-packaged solid roof that can be configured to suit virtually any existing conservatory roof that is to be converted.- variable pitches and differential pitches no problem.
- Livingroof is based on BBA certified Classic roof chassis, the first glazed roof with this important third party accreditation and the only solid roof replacement product based on a BBA certified platform.
- Livingroof has partnered with Stroma, Approved Building Control Inspectors. In England and Wales they can undertake Building Regulation inspections for a uniform approach across all localities. See separate brochure for Stroma information and application form.
- U-value of 0.15 W/m2K – warm roof, vaulted ceiling, with the option to reduce to 0.12
- Features insulated internal pelmet system set at 300mm projection (ability to vary projection too), better finishing detail at eaves and perfect for cables and lights.
- Glass panels can be integrated to maintain light into any adjacent room – no additional cost to swap solid panels for high performance glazing.
- Everything is pre-fabricated in our highly efficient factory to ensure rapid one day fit on site.
- On a 4m x 4m Georgian, the system weight is 31kg/M² including plasterboard (12kg/m² polycarbonate roof and 30kg for a glass roof).

Building Regulations requirement

Livingroof takes a responsible position and recognises that this glazed to solid conversion activity means the conservatory is no longer exempt. Checks should be made on the structural integrity of the frames and base before conversion takes place. Livingroof recommends various techniques to check/upgrade existing frames/bases. Livingroof can also be used in new extensions.

U-Design

U-Design is a piece of design and configuration software that exclusively specifies Livingroof. As well as visualising and pricing, upon entry of the customers postcode it checks the wind and snow loads at the exact location to ensure Livingroof comply's with Building Regulations.

It is strongly recommended that the Livingroof installation guide and the Building Regulations process brochure are read at the same time as this System Overview Design Guide



01

The Livingroof roof has a 0.15 U-value which is 15 times more thermally efficient than a 16mm polycarbonate or older glass roof without solar control.

The room will be cooler in the summer and warmer in the winter.

Heating costs will be reduced.

The room can be used 365 days of the year.

It's worth offering the homeowner the options of new frames, since modern glazing specifications will complement the thermal performance of the roof making the room more comfortable & cheaper to heat.

02

Partnered with Stroma to provide Building Regulations completion certificates (England & Wales)

Building Regulation compliance is required for solid roof conversions and new build extensions. The Stroma partnership provides peace of mind regarding the performance of the roof and to ensure that there are no problems with compliance when the homeowner decides to sell their home.

Stroma provides a low cost consistent way of complying with Building Regulations across England and Wales in a practical, pragmatic approach.

03

Livingroof is supplied in RAL7016 Urban Grey as standard.

This has the appearance of a rolled lead roof with a conservatory feel.

When installed it looks very similar to the appearance of a subtle blue glass roof, reflecting the sky.

It is less likely to show the dirt whereas other colours may.

TOP TEN MAJOR FEATURES & BENEFITS



04

Livingroof has a system weight of 31kg/m² (including plasterboard) – much lighter than other replacement roofs.

Whilst around the same weight as a glass roof this often enables the original window frames to be used providing a saving to the homeowner if required.

The difference in loading on the foundations is negligible. Provided there is no sign of settlement in the base there is no need to excavate a pilot hole to reveal the foundations. Please consult Stroma if you are in any doubt.

05

Livingroof is offered with black Marley Classic gutter as standard with the option to have the powder coated Cornice.

The PVCu gutter option enables homeowners with a tight budget to take advantage of the benefits of Livingroof.

Cornice provides the wow factor! The easy to install system can be specified in grey to match the roof, the same colour as the frames, or in a bespoke colour that complements or contrasts with the frames. This enables the homeowner to be creative and make their mark on their new home improvement project.

06

Glass panels can be integrated virtually anywhere into the design of the Livinroof without additional cost to the home owner. This includes shaped panels.

This adds visual appeal to the design of the extension.

The homeowner has an individual design that is their own.

Take advantage of the sweep of the sun over the extension by choosing which panels to glaze and which to leave solid. Which brings light into rooms in the house that would otherwise be darker with a solid roof.

Watch TV in the Livinroof extension without suffering problems with glare whilst having the benefit of natural light.

Unlike other solid roofs, brings more light into the room adjacent, crucial if replacing an old glazed roof.



07

An insulated internal pelmet is part of the design, with a horizontal soffit inside the extension. The standard projection of the insulated internal pelmet is 300mm but it can be varied, (with a max up to 1200mm).

You can put downlights of your choice within the insulated internal pelmet around the perimeter of the extension, providing attractive mood lighting.

You could fit speakers to insulated internal pelmet with hidden cables led through to your amplifier, this should be considered for first-fix cabling.

08

Livinroof has a vaulted ceiling and a plastered finish.

The vaulted ceiling provides a light spacious feel to the extension.

The plasterboard finish makes the extension feel as though it is part of the house.

It can be integrated with Super-insulated columns to improve thermal performance, provide visual appeal and reduce build times.

09



Livinroof is based on the Classic BBA certified platform and carries a 10 year guarantee

The roof has a proven pedigree and will provide comfort and peace of mind for the homeowner for many years to come.

The roof can be configured like any other conservatory roof, providing the retailer with confidence that they can replicate existing designs on refurbishment projects.

The Classic system enables variable pitches to be specified, useful when height restriction apply, including the ability to produce lean-to designs as low as 5 degrees.

Fitters are familiar with the system, so a speedy swop from old to new with no risk of damaging existing floors/finishes.

10

Create a simple plastered 'flat top' at the apex to suspend lights from.

This allows the homeowner to specify downlights or pendant lights of their choice to be fixed under the ridge for main or mood lighting.

Adds further visual identity to the extension roof internally.

PRINCIPLES OF REPLACING CONSERVATORY ROOFS

Livinroof is a responsible manufacturer and takes its market position seriously. There is some confusion out in the market amongst those who already have or are about to tackle their first glazed to solid conversion.

Livinroof has consulted with the leading Approved Building Control Inspectors Stroma and Assent Building Control and our advice and notes are based on their positions – both organisations believe that Building Regulations DO apply when glazed to solid roof conversion work is executed.

As a responsible member of the Glass and Glazing Federation, our position is one that ALL responsible retailers MUST follow these guidelines.

Changing the roof on a previously exempt conservatory from glazing to solid panels means that you have changed the status of the structure. The new roof is seen as an improvement and MUST comply with parts of the Building Regulations (this assumes the doors separating the house and conservatory are retained). There is a caveat – the replacement roof should not make the condition of the existing structure worse – this relates to the ability of the existing side frames and foundations to carry the additional loads imposed by the solid roof.

Providing adequate support can be reviewed for three main areas;

1. Window frames
2. Mullions/corner posts
3. Foundations

Pages 13-18 give detailed guidance on how to assess these areas and ensure compliance.

Whilst our products have been designed to comply with the thermal requirements of building regulations a combination of high humidity (kitchen/laundry etc) and poor ventilation could result in surface condensation. Keeping surfaces clean limits the opportunity for mould growth as a result of the condensation and therefore regular maintenance is required to keep a healthy home in these conditions.



The minimum fire performance rating required by Building Regulations for roofs is AC based on the following classifications.

FIRST LETTER

PENETRATION CLASSIFICATIONS

- A** Specimens not penetrated within 1 hour
- B** Specimens penetrated in not less than half hour
- C** Specimens penetrated in less than half hour
- D** Specimens penetrated in the preliminary flame test

SECOND LETTER

SPREAD OF FLAME CLASSIFICATIONS

- A** Specimens with no spread of flame
- B** Specimens with not more than 533mm spread of flame
- C** Specimens with more than 533mm spread of flame
- D** Specimens which continue to burn for 5 mins after the withdrawal of the test flame or spread more than 381mm in the preliminary test.

The assembled Livinroof has been independently fire tested by Exova Warrington Fire and has been rated: AA when 25mm aluminium faced sandwich panel installed. AB when 25mm U-Tec composite panel installed.

Certificates available to download <https://trade.ultraframe-conservatories.co.uk/trade/our-products/fire-safety/>
The full report is available on request from Ultraframe.

HUP!

Livinroof is compatible with the hup! walling system.

The pelmet in the hybrid roof must be a minimum of 400mm wide as shown above - this can be increased up to 1200mm.

A top tray runs along the top of the hup! walls underneath the eaves beam. The clips are screwed under the top tray. Raked frames must be used on lean-to roofs as the walls cannot be raked and meet the panels/starter bar. Internally the top tray meets the edge of the internal pelmet or it can be wider.

Because hup! walls are ordered to external base datums which sit inside of the external wall and Livinroof is ordered from internal frame datums. Therefore when ordering a Livinroof with hup! walls, order walls to external base and deduct 70mm from each elevation to determine your roof size.

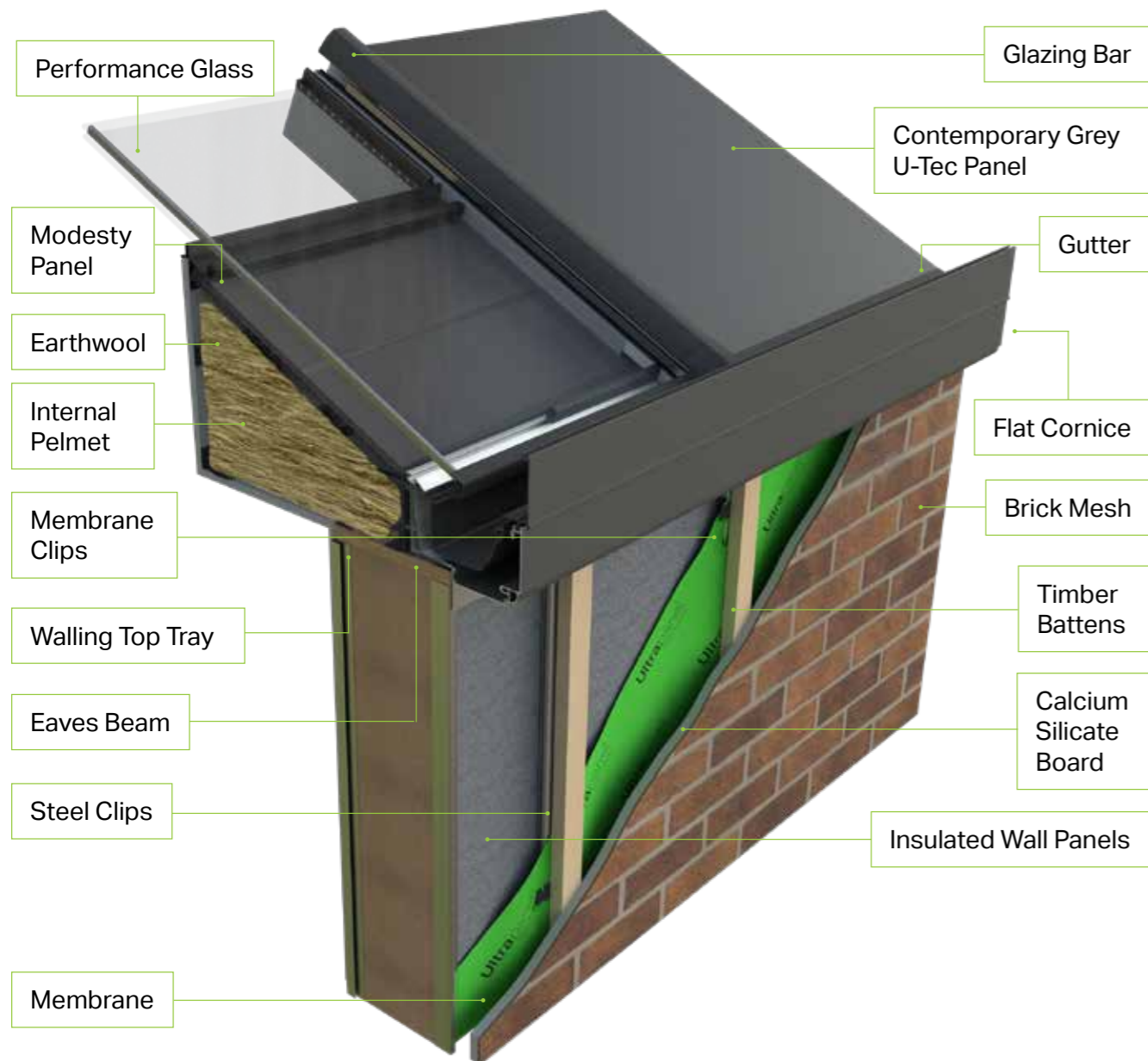

LIVINROOF THERMAL IMPROVEMENTS

Additional Parts Supplied.

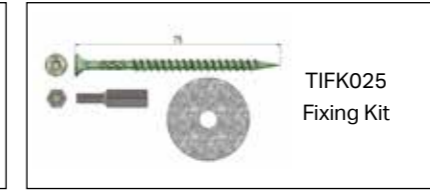
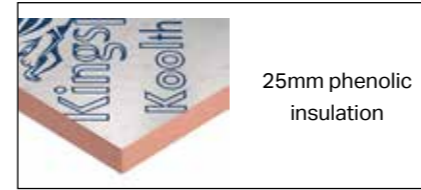

Transoms Cross Section

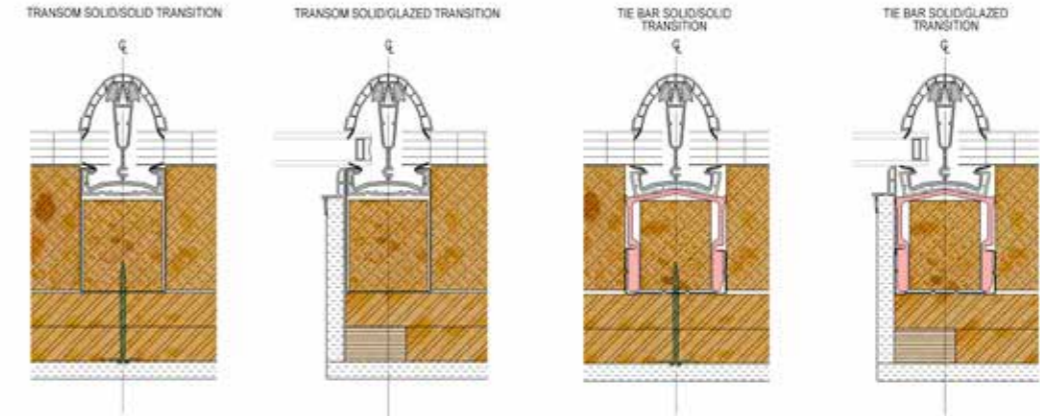

Hips Cross Section

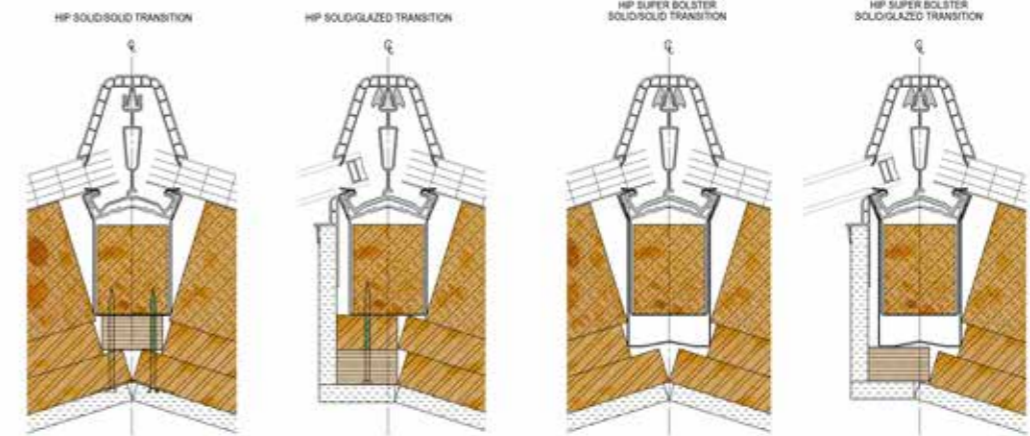

Starter / Gable Cross Section

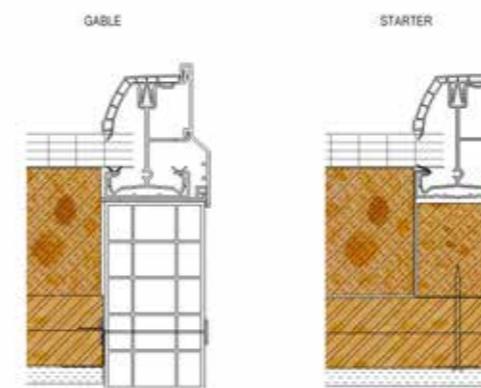

Valley Cross Section

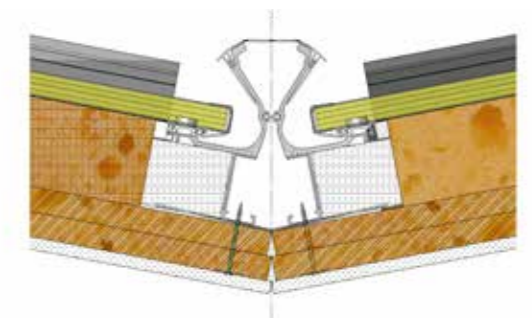

LIVINROOF THERMAL IMPROVEMENTS

Transom Solid / Solid

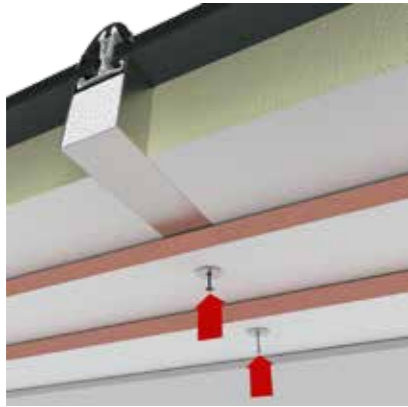

Transom Solid / Glazed

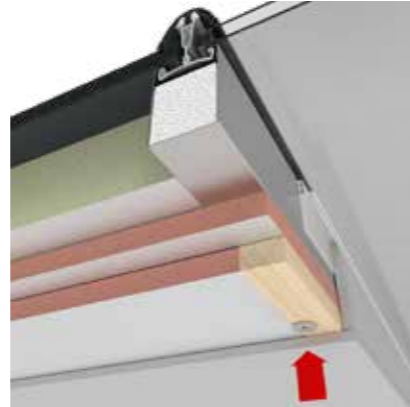

Secure the first layer of 25mm insulation using the LVIK025 fixing kit. If solid / glazed, fix LVBG240 timber batten to the underside of the first layer of insulation. Apply the second layer of 25mm insulation beneath the first and secure with the provided TIFK025 fixing kit.*

Starter

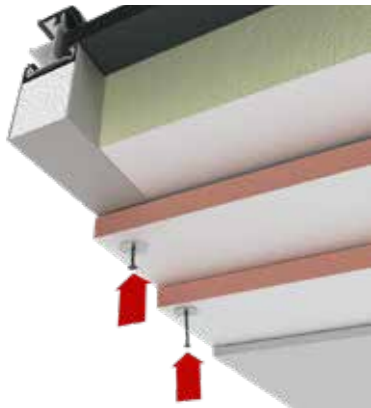

Valley

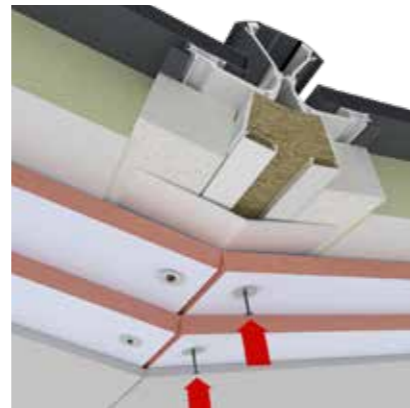

Secure the first layer of 25mm insulation using the LVIK025 fixing kit. Apply the second layer of 25mm insulation beneath the first and secure with the provided TIFK025 fixing kit.*

Transom Solid / Solid Gable

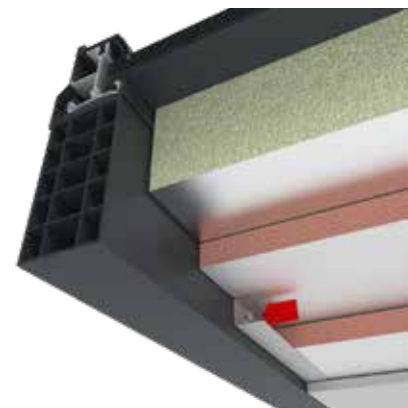

Secure the first layer of 25mm insulation using the LVIK025 fixing kit. Screw CHA405/1 steel C channel to the side of the chambered box on the underside of the first layer of insulation. Apply the second layer of 25mm insulation beneath the first pushed into the C channel and secure with the provided TIFK025 fixing kit.*

Standard Hip

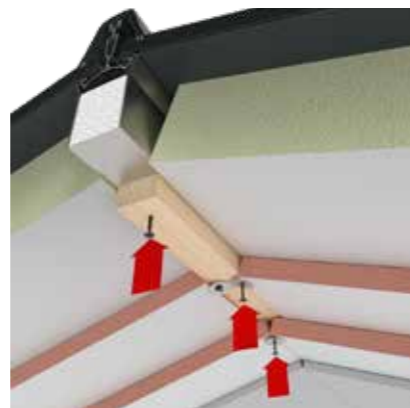

Fix provided 25mm x 44mm timber batten LVBG240 to the centre of the hip bar box section (1). Secure the first layer of 25mm insulation up against the fitted timber batten using the LVIK025 fixing kit. Apply the second layer of 25mm insulation beneath the first, overlapping the timber batten and secure with the provided TIFK025 fixing kit.*

*Ensure that all lower insulation joints are taped with foil sealing tape LVFT045.

CLASSIC ROOF CHASSIS – SIMILARITIES AND DIFFERENCES

Livinroof is based on the highly configurable BBA certified Classic roof chassis which gives the roof tremendous ability to accommodate varying pitches, sizes and shapes. It will nearly always be the case that if there is an existing conservatory roof to be replaced, Livinroof will be able to substitute a roof that is extremely similar.

Although based on the Classic Chassis, there are a number of elements / parts that are new or that exist as options today and that will be mandatory on Livinroof. At the heart of Livinroof is an insulated steel bolster glazing bar which greatly increases the strength / span performance and which provides a sound fixing for the 12.5mm plasterboard. Linked to the point above is the reduction in bar centres to 600mm. This ensures that the plasterboard is correctly supported and eliminates movement deflection (leading to micro cracking in the plasterwork). The roof now features the eaves beam mouldings at host wall positions (resin anchor fixed) and the compression plate at the ridge end. These items are part of the existing TBRK (tie bar replacement kit – in some situations a bolster is added at the ridge and additional cleats specified at the eaves beam corners).



At the heart of Livinroof is a series of insulated bolstered glazing bars – boosts spanning and reduces deflection.

All roofs feature struts at the ridge, covered by an insulated ridge board. See p22 Appendix 3 for further guidance on struts and various tie bar situations/options



Where the eaves beam sits against the host masonry wall, it has a structural moulding attached to the eaves beam. This has three fixing positions cast into it to allow attachment into masonry – choose the hole that directly lines up with solid masonry and attach using one resin anchor suitable for substrate / loads (not supplied, see p21 Appendix 1).



The ridge hanger/compression plate is attached to the host wall using two anchor bolts (not supplied).

ADDITIONAL STRUCTURAL SPECIFICATION ITEMS (SOFTWARE SPECIFIES)

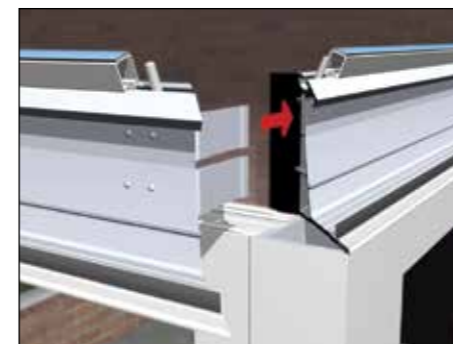

Each eaves corner (90°, 135° and 150°) is supplied pre-fitted with an additional standard cleat. Additional cleat (2 in total) on 90°, 135° and 150° corners.

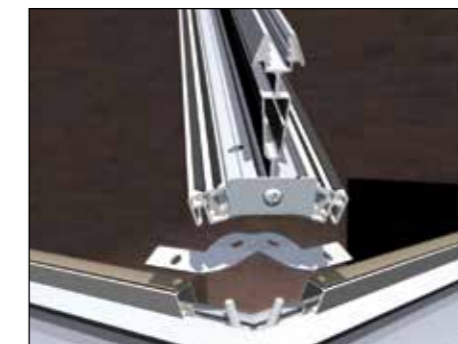

On Georgian / 90° corners, a butterfly cleat is laid over two captivated roofing bolts. Note: A butterfly cleat is not required on 3 or 5 facet fronts unless the eaves beam joins a box gutter at the facet joint.

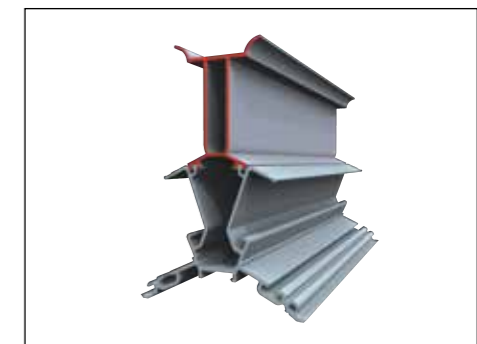

An aluminium bolster beam is factory stitched and extends along the entire length of the ridge and acts as one with the existing aluminium ridge body to virtually eliminate deflection.

SYSTEM OVERVIEW

Transom Bar - solid/glass - on fascia



Transom Bar - solid/glass - below fascia



*** IMPORTANT - ALL INTERNAL PELMETS TO BE FULLY INSULATED WITH MINERAL WOOL**

SYSTEM OVERVIEW

Box Gutter - solid/glass - below fascia



Box Gutter - solid/solid - below fascia



*** IMPORTANT - ALL INTERNAL PELMETS TO BE FULLY INSULATED WITH MINERAL WOOL**

SYSTEM OVERVIEW

Valley - solid/solid



Hip - solid/solid



*** IMPORTANT - ALL INTERNAL PELMETS TO BE FULLY INSULATED WITH MINERAL WOOL**

SYSTEM OVERVIEW

Gable - glass

PLEASE DO NOT ORDER / MANUFACTURE GABLE FRAMES BEFORE DISCUSSION WITH TECHNICAL SUPPORT ON 01200 452918.

Gable frame sizes on Livinroof roofs are different to regular glazed Classic Roofs.



Gable - solid

PLEASE DO NOT ORDER / MANUFACTURE GABLE FRAMES BEFORE DISCUSSION WITH TECHNICAL SUPPORT ON 01200 452918.

Gable frame sizes on Livinroof roofs are different to regular glazed Classic Roofs.

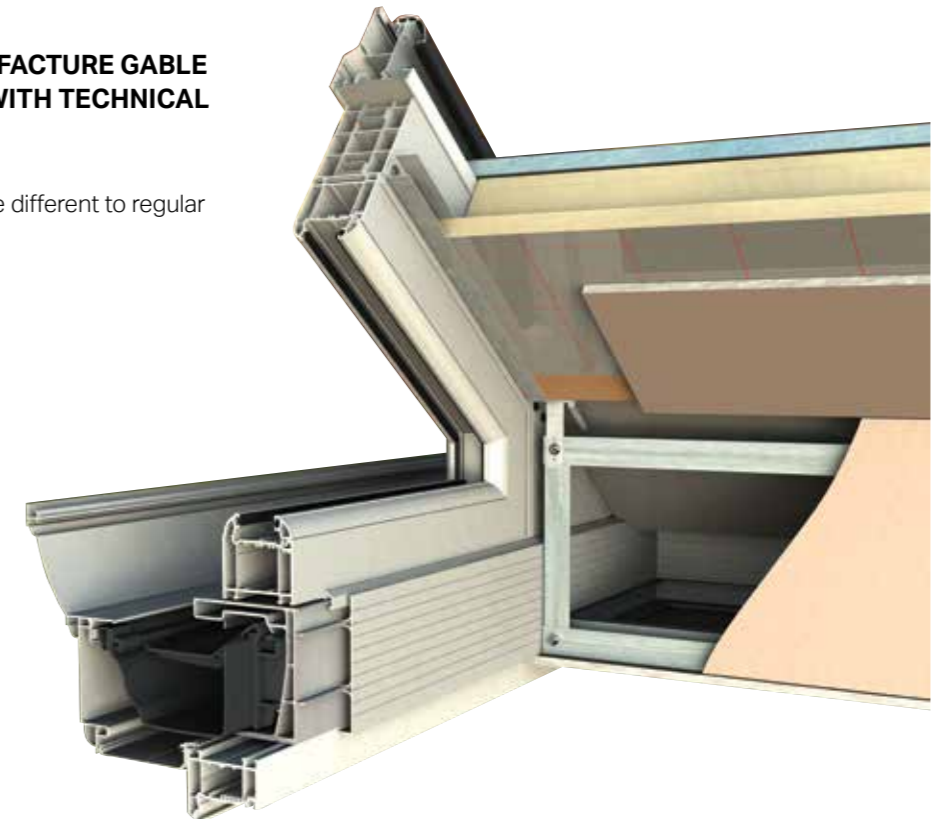

*** IMPORTANT - ALL INTERNAL PELMETS TO BE FULLY INSULATED WITH MINERAL WOOL**

PANEL SIZES / CENTRES

Unlike traditional glazed roofs where bar centres typically are 750 - 900mm apart, on Livinroof they are at a maximum standard of 600mm centres - this is because plasterboard is a material that needs further support than a traditional glass roof (to prevent deflection and thereby micro cracking in the plasterwork). See additional notes below.

The design/manufacturing software specifies bar spacings and panel sizes.

Bar layout on 4 x 4m Georgian Roof

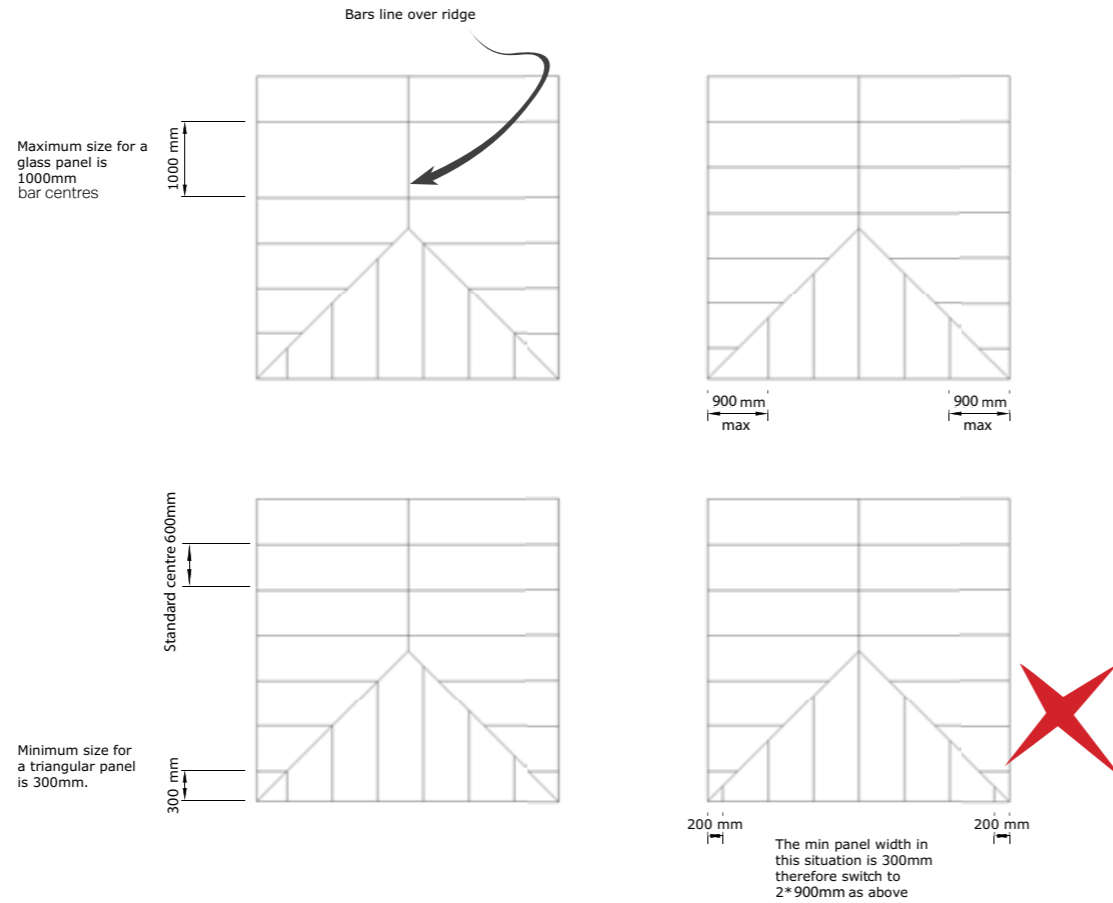

Bar layout on 4 x 4m Victorian & Lean-to Roof

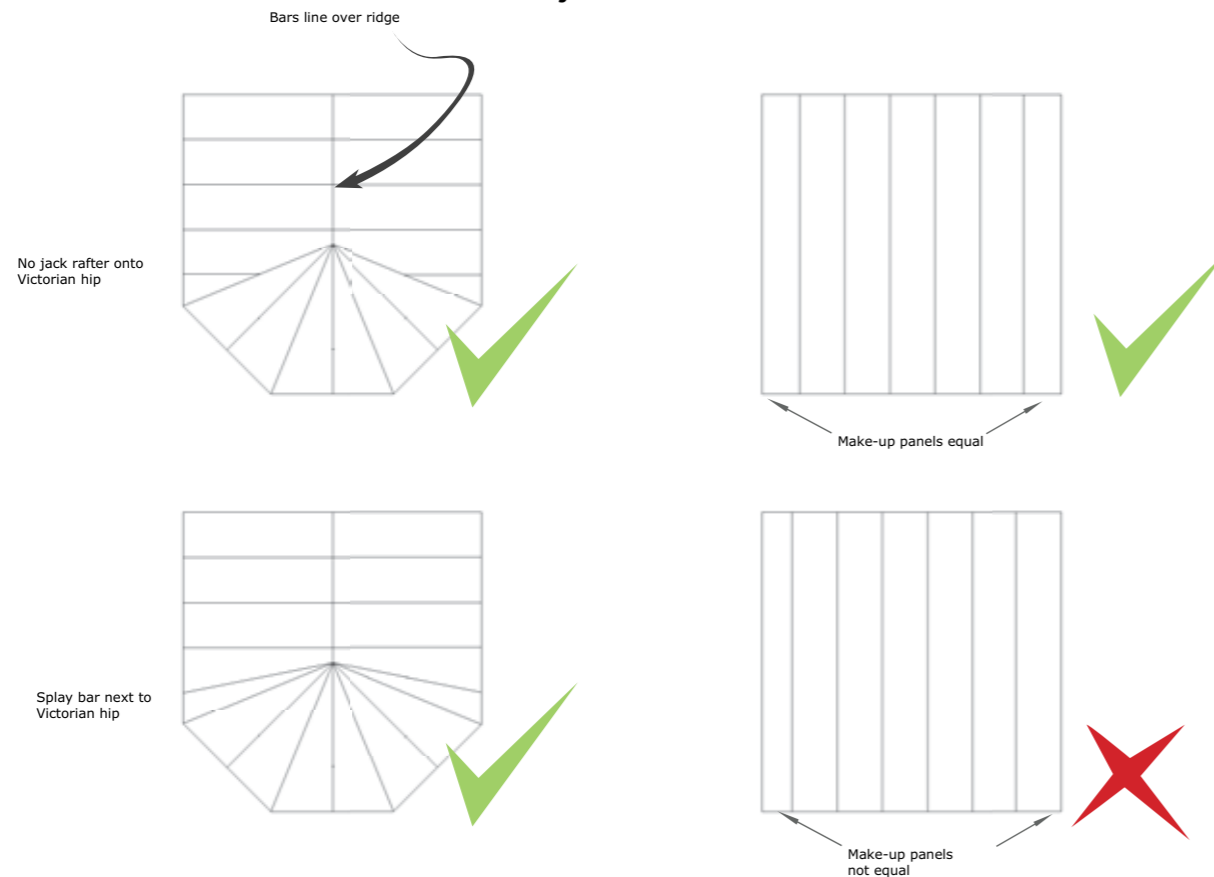

GLAZED PANEL LAYOUT GUIDANCE

Glass panels can be inserted in virtually any position within the roof. If Livinroof is used as part of a new extension, only 25% of the floor area can be represented as glazed elements (vertical wall frames and roof combined). For example: a 4mx4m floor plan means only 4sqm of allowable glazing, using windows or doors with the minimum allowable U-value of 1.4 W/m²K.

Additionally, you can add to the total area of any windows and doors which no longer exist or are no longer exposed due to the extension.

Deploying units with improved U-values may increase the percentage of allowable glazing. Obtaining SAP calculations or achieving 'trade offs' via Stroma will confirm this.

Bars line over ridge

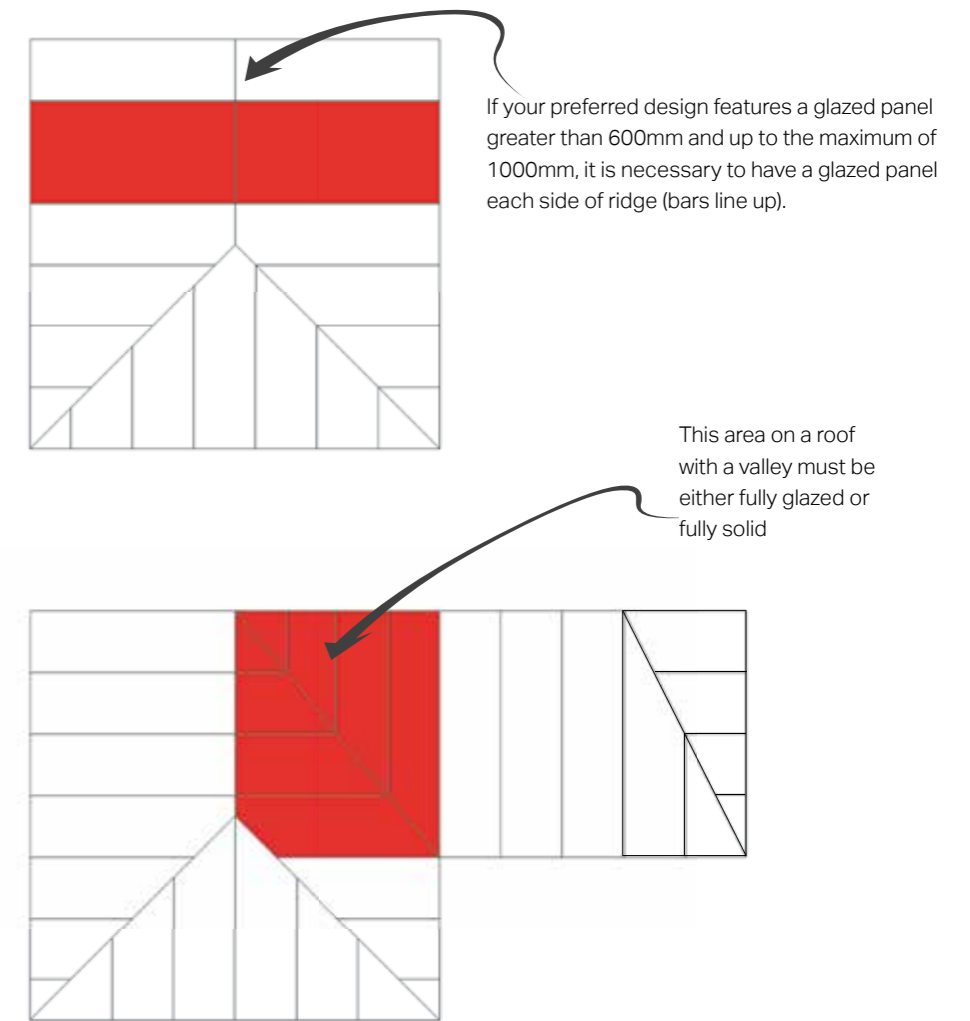

Solid Panel Shapes max/min sizes

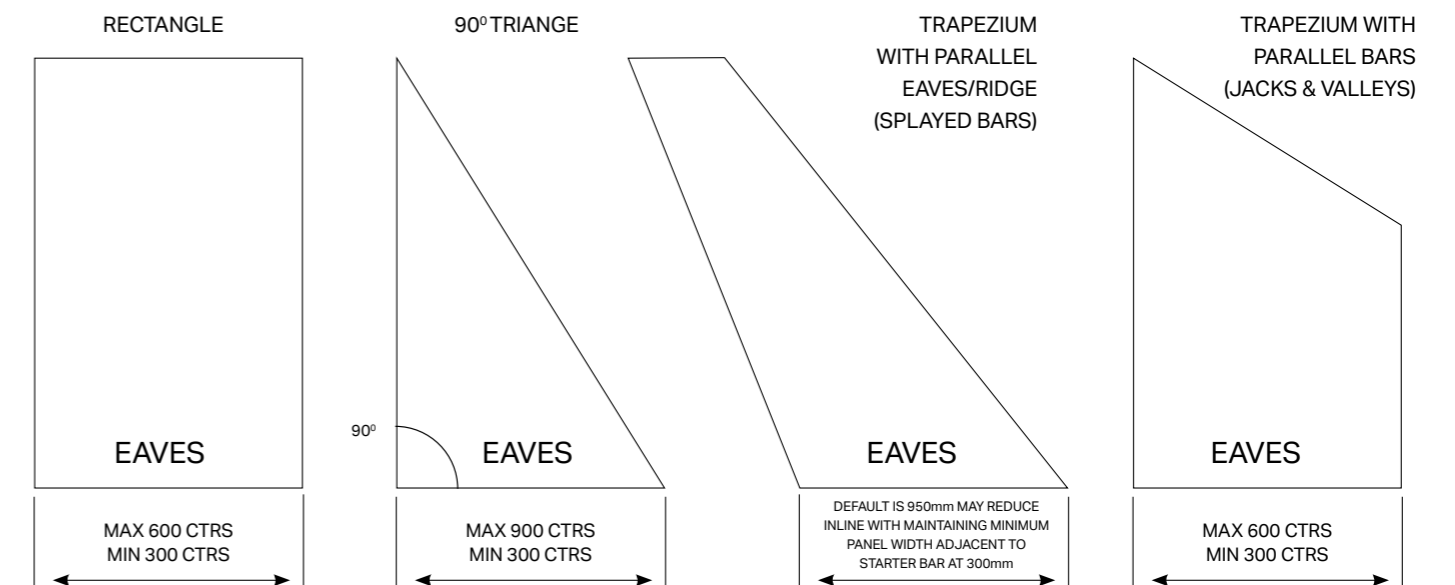

ASSESSING THE EXISTING CONSERVATORY - STRUCTURAL SPECIFICATION GUIDELINES

To upgrade an existing conservatory roof from polycarbonate or poorly performing glass to solid panels, it is necessary to undertake some structural checks that MAY lead to additional site works.

1. PVCu Window Frames

- Unreinforced PVCu Frames. If at survey stage there is no reinforcement within the PVCu frames then the normal method of attaching the roof to the frames MUST NOT be used. The recommended method is the long standing Victorian fixing kit which uses a threaded rod and concealed nuts. Alternatively, if there is the option to screw up through the head of the frames, use a stainless steel screw, then behind the head of the screw should be a 20mm washer, so that the thread is biting into the aluminium of the eaves. Snip off excess thread to ensure screw doesn't foul gutter. Either option is suitable. **To achieve 0.12 frame extensions will be required, see page 9 & 10 for more details.**
- Reinforced PVCu Frames. If at survey stage there is partial reinforcement (head of the frames as a minimum), then this helps with the connection of screws, particularly when screwing into the frame. For example when securing the roof to a window frame below with a screw going down through the eaves beam, the screw must go into steel reinforcement within the window frame.

Preferred method - all situations

If no reinforcing - screw up (avoiding penetration of the gutter)

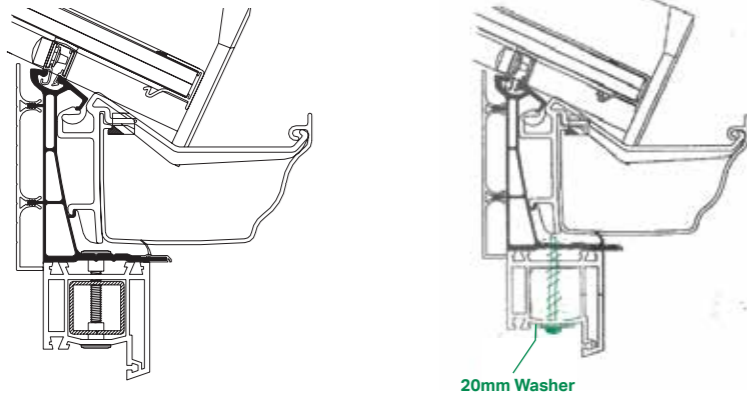

2a. Corner Posts

- Unreinforced PVCu Frames. If at survey stage there is no reinforcement within the PVCu frames it may be necessary to replace the corner posts. The dead load of Livinroof is 31Kg/m² plus the snow load which as a minimum is typically 60kg/m². On a 5m x 5m roof for example, the load is 3414Kg which translates to a maximum loading at each corner of 8.37kN. Using the table below it can be seen that an aluminium corner post of 50mm square hollow section with a 2mm wall will be adequate - generally corner posts will be larger than this. At survey stage it may be difficult to confirm the presence of the aluminium inside the PVCu sleeve until the roof is removed. Assuming new frames are not being installed, it may be advisable to have spare corner posts available to swop with the existing.

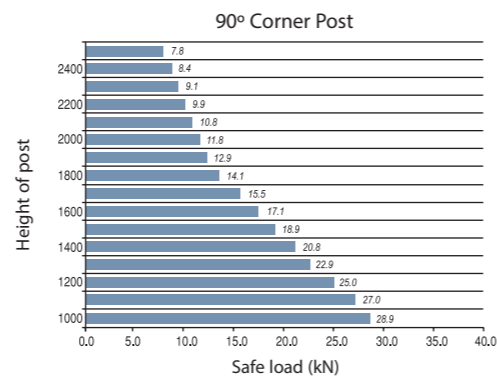
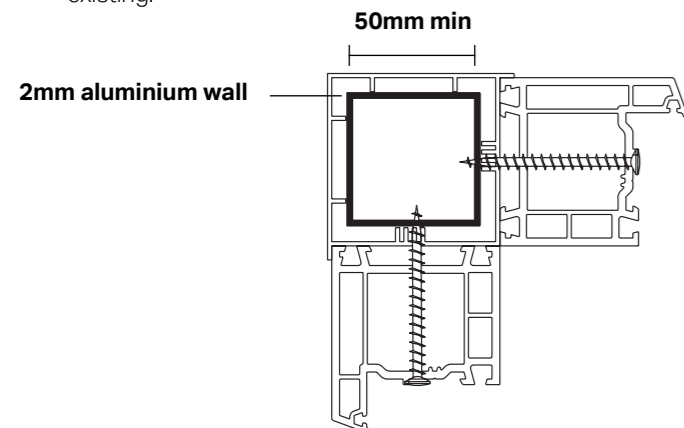

ASSESSING THE EXISTING CONSERVATORY - STRUCTURAL SPECIFICATION GUIDELINES

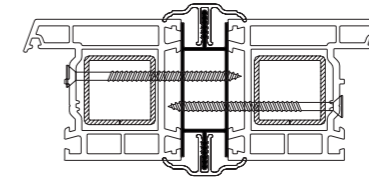

2b. Mullions

- An aluminium mullion performs a number of functions, namely;
 - acting as a wind post to prevent deflection of the frames by wind pressure
 - to support the roof's eaves beam
 - to assist with the connection of the side frames.
- Mullion as a wind post:- the size of the mullion depends on the height of the frame. With full height frames (2100mm) the mullion needs to be the full front to backdepth of the window frame and at least 20mm wide.
- Adding mullions to any existing frames is not viable – this option should be considered if the consumer has requested new frames/doors. Should the PVCu frames be replaced, the insertion of suitable mullions can obviate the need for reinforcement in the frames (as far as structural reasons are concerned) – when using mullions, always place a 20mm washer behind the head of the screw (similar instruction as to eaves beam).

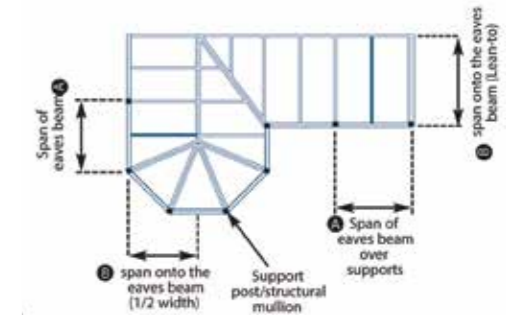
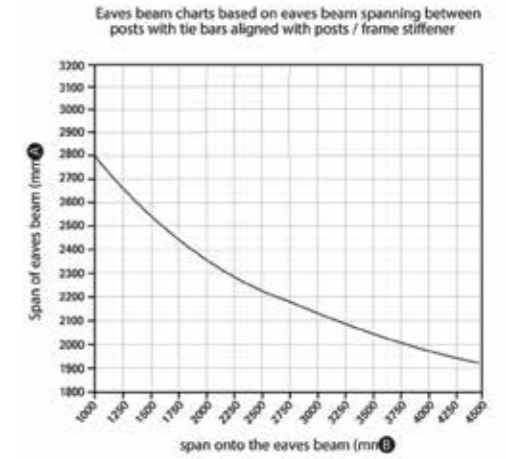

WHERE FRAME DESIGN DOES NOT ALLOW RETRO FITMENT OF MULLIONS, ONE OPTION MAYBE TO UPGRADE FROM STANDARD EAVES BEAM TO SUPER DUTY EAVES BEAM - See p23 Appendix 4

3. Foundations

- As everyone knows and appreciates, foundation design greatly depends on local ground conditions and advice should be sought from an Approved Inspector likeStroma. However there are some rules which are absolute and therefore if the proposed conservatory falls outside this it will be necessary to underpin the existing or rip up the base and start again. Take up the old foundations if;
 - There is an inadequate depth of foundation. The strip foundation MUST be a minimum of 450mm and the concrete strip a minimum of 150mm thick.
 - There is visible movement between the house wall and the conservatory dwarf wall or cracks in the dwarf wall - this is a clear indication the foundations are not adequate and also require remedial work.
 - Remediation work (mini piling etc.) can be undertaken cost effectively – recommendation is QUICKBASE 0845 644 0000 if you wish to persue this option.

IF IN DOUBT ABOUT STRUCTURAL COMPLIANCE, PLEASE CONSULT STROMA OR A STRUCTURAL ENGINEER

ASSESSING THE EXISTING CONSERVATORY - BOX GUTTERS

A key part of assessing the existing conservatory's suitability for upgrading is to assess any box gutter requirements, but in particular how they are adequately supported.

Thermal Requirements

The roof itself is compliant with the Building Regulation's requirements and therefore if the thermally separating doors are being kept in place there will be no further considerations that need to be taken into account. Within building regulations there is an allowance for 25% of the floor area to have roof lights, windows or doors fitted. This is based on performance of 1.4W/m²K for both windows and glass doors, therefore if better glass is used together with the better performance of the roof up to 30% glass is possible and still comply. U-Design provides guidance on this for precise calculations.

If the thermally separating doors are to be removed there are two main options.

1. Make the conservatory comply to building regulations on an elemental basis i.e .

Walls	0.18 W/m ² K
Floor	0.18 W/m ² K
Windows	1.4 W/m ² K (windows energy rating band B)
*Doors	1.4 W/m ² K (windows energy rating band C)

* with more than 60% of internal face glazed

2. Alternatively a SAP calculation is required on the whole house this approach allows offsets to be made i.e. new boiler or insulating the loft. SAP calculations need to be conducted by professional SAP assessors. Such as Approved Inspector Stroma.

Minimising Spread of flame.

In situations where the side wall is within 1m of the boundary there should be a firewall with a maximum opening for a window of 1m². If this is not possible alternative measures will be required such as a solid brick built wall along the boundary or a solid timber lap fence would be adequate.

Hip

Hip bars (without a tie bar at finial point) are under compression (at the bottom they are pushing on the box gutter) when the box gutter is raised back the hip bar does not strike though the corner but sits on top of the plate. The plate is not strong enough to support this load, so the bolstered gallows bracket is used and the hip bar is fixed to the top of it with 4 No M6 bolts.

Transom Tie Bar Support

Where a Tie Bar hits a raised back box gutter; the plate on the box gutter requires support. Transom bars connected by tie bars act as a truss and produce a concentrated point load at their location. Occasionally we can use two hanging brackets, but predominantly we use bolstered gallows brackets to support this load. Please note where the tie bar is more than a quarter way up the glazing bar; the tie bar bracket has to be fixed to the gallows bracket and not the glazing bar.

Tie Beam & Tie Bar support

Is it not always possible to place a bolstered gallows bracket directly under the transom tie bar, due to window/door openings. Where this occurs two gallows brackets are placed either side of the opening and a beam is joined to the top of these brackets. This beam distributes the concentrated load (from the tie bar) to these gallows brackets. This design is sometimes used on box gutters that rise above 500mm, to provide support to the plate.

Maintaining a Healthy Environment

Ensure there are opening windows so that the room can be ventilated now and then. Finishes are suitable for regular cleaning.



Custom designed gallows brackets are sometimes required

ASSESSING THE EXISTING CONSERVATORY - BOX GUTTERS

The structural performance of the box gutter relies on the correct specification of fixings - please consult fixing suppliers for advice.

Gallows Bracket

Requirements for Gallows Bracket –

- Roofs with tie bars require a gallows bracket at each tie bar position.
- Roofs over 3.0m width or projection require a gallows bracket at every fourth glazing bar (ie typically 2.4m centres).
- Livinroof has a spanning capability up to 4m without the requirement for gallows brackets.
- Maximum span for unsupported box gutters (no fixings into house wall).



Alternative Support

- Unless the strength of the masonry to which the gutter is attached is known, Livinroof generally recommends the use of brick piers to support the boxgutter, suitably tied to the host wall using a proprietary fixing rail/tie irons. A minimum expected size is 225 x 225mm.
- With timber soffits and fascias, Livinroof generally recommends the use of brick piers to support the box gutter.



Further Requirements

- Straps required for all box gutters.
- Straps to be positioned within 75mm of glazing bar centres (centre of strap to centre of bar).
- Box gutter is only available in a 165mm wide version. 20mm minimum frame add on is required around standard eaves with 'on fascia' and 60mm when 'below fascia'.



Hanger Bracket - alternative support for 165mm box gutters.



Top: 165mm Standard box gutter. Above: 265mm Standard box gutter.

REINFORCED BOX GUTTER

- A factory insulated reinforced box gutter that enables a 6M span with 265mm box gutter
- Must be supported either end by hup!, brick wall, or aluminium post *
- Reduces / eliminates the need for gallows brackets on bungalows
- Breaks in the I beam allow for water flow and fixing access & point at the image
- The maximum length of box gutter is 6m, to suit internal frame size of 5860mm.
- The box gutter can be jointed every 5.8m. Joints must be supported at each location and specified when ordering
- Whole assembly will be pre-welded
- Can be used on all Glass Roof and Livinroof
- The weight of the beam is 13kg/m, therefore lifting should be considered.



Details for supporting an aluminium post*, please contact Ultraframe

IMPORTANT:

The standard or chambered box gutter is 165mm wide (for use when collecting from a single roof). The 265mm wide box gutter is used to give extra capacity when collecting from two roofs eg. bungalow situations etc.

APPENDIX 1 - RESIN ANCHORS

The correct selection/specification of fixings for Livinroof is CRITICAL.

Recommendations is HILTI chemical anchors where specified and expanding anchors in other locations (to resist pull out forces). Using HILTI product codes/descriptions, use a HIT-V 80mm x M8 threaded anchor (stud*) fastened into a 10mm clean drill hole with gun injected mortar or adhesive capsules (with a minimum 80mm embedded) - always rigorously follow manufacturers guidance www.hilti.com

In addition a recommendation are the following alternatives;

Fischer M8/M10 masonry injection anchor FIS V

Rawl Fixings M8/M10 CFS RM50 or CFS RP30

* Design load for each stud 2.5kN

APPENDIX 2 - CAVITY TRAY ASSESSMENT

It is good practice to undertake a risk assessment to determine IF cavity trays should be retro fitted.

In zones 1 and 2, cavity tray installation is based upon risk assessment - factors include determining if elevation faces prevailing wind, absorbancy of brickwork and monitor joint type. Cavity trays **MUST** be installed in severe/very severe exposure zones (3 and 4).



KEY	EXPOSURE ZONES	Approximate wind-driven rain* (litres/m ² per spell)
	1 Sheltered	Less than 33
	2 Moderate	33 to less than 58.5
	3 Severe	58.5 to less than 100
	4 Very Severe	100 or more

* Maximum wall spell index derived from BS8104

APPENDIX 3 - TIE BARS

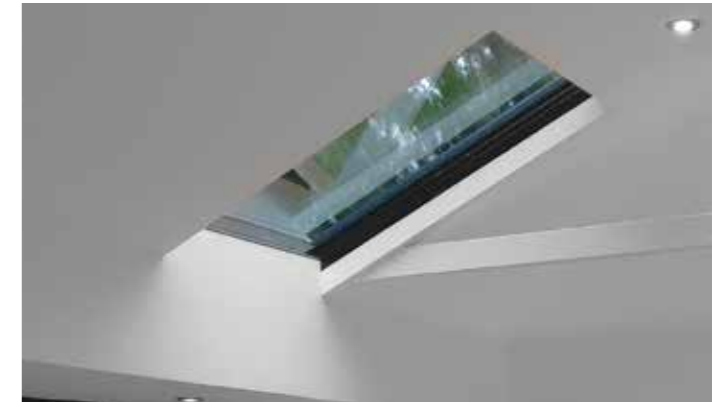
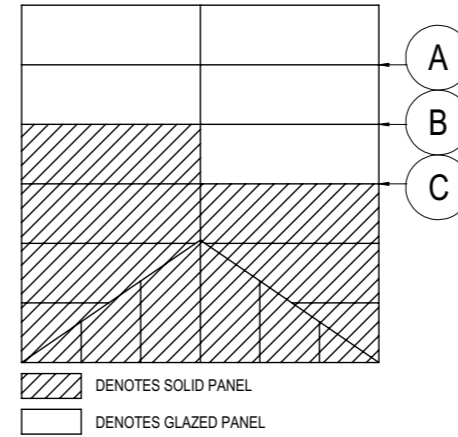

Tie beam

Glass - glass
Traditional Tie bar

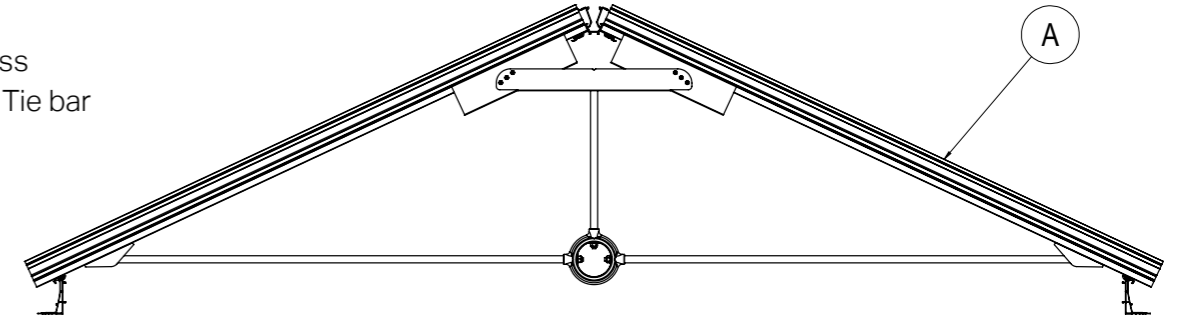

Solid - glass
Traditional Tie bar

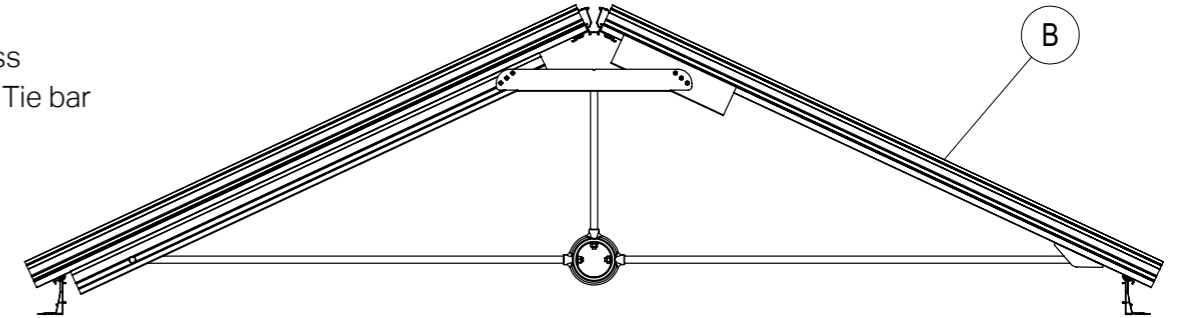

Solid - solid
Traditional Tie bar

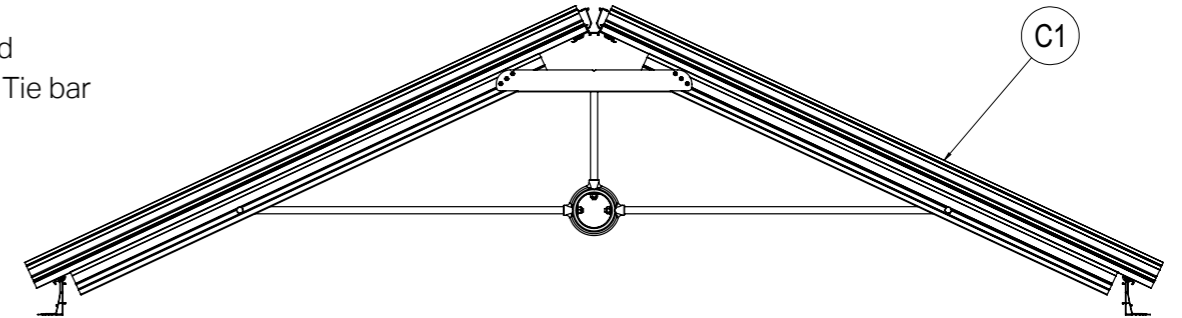

Solid - solid (Standard Option)
Tie beam

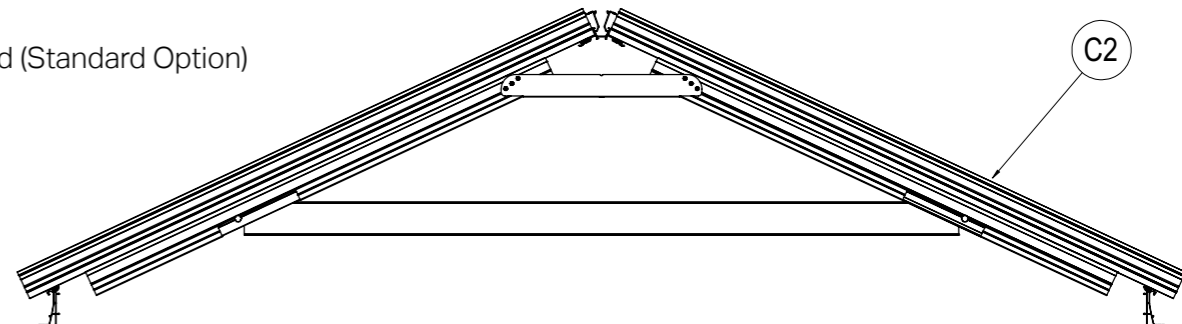

APPENDIX 4 - BI FOLD SUPPORT BEAM & EAVES SUPER BOLSTER

- Bi-fold support beam which mounts to the underside of the eaves.
- Eaves super bolster which mounts to the inside of the eaves beam.
- The bi-fold support beam and eaves super bolster profiles can be used separately to bolster the eaves or combined to further increase the spanning capability.
- The bolster sections only need to be specified on the elevation where the larger opening is required.
- The bi-fold support beam is 70mm tall and runs between corner posts.
- The eaves super bolster support beam is 134mm tall.
- uPVC claddings on internal and external fascia.

On the elevations which do not require the spanning capability, either the frame height can be adjusted, or a standard frame add on or corner post profile can be used to pack the frames under the eaves.

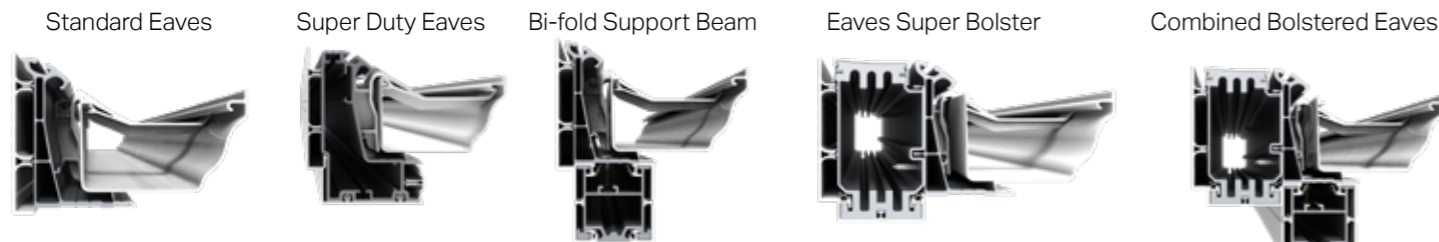

THE CLASSIC SYSTEM - SUPER DUTY EAVES

The Super Duty Eaves Beam should be specified where additional spanning performance is needed, allowing confident specification of folding/sliding doors (or indeed any type of opening such as in-line sliders).

TECHNICAL SPECIFICATION SUPER DUTY EAVES BEAM

- Structural 'beefier' aluminium profile that uses existing PVCu components to clad and cap for optimum performance
- Sits 38mm taller than the standard eaves beam (remember this when calculating overall ridge heights).
- Needs to be specified all the way round the nominated conservatory and NOT simply on the facet into which the doors are to be fitted.
- Readily interfaces with box gutters and Gable Support Beam, to offer maximum integration and configurability
- The span charts need to be studied carefully BEFORE conservatory selling and design starts... the elevation into which the doors are to be fitted, the style of conservatory and the 'span onto' dimension all affect the maximum allowable width of opening when using the Super Duty Eaves Beam.
- If a conservatory design requires an opening width greater than that which can be offered with the Super Duty Eaves beam, then consider bi fold support eaves or super bolster eaves or both combined. If greater a portal/goalpost arrangement will be needed – can provide a custom solution.

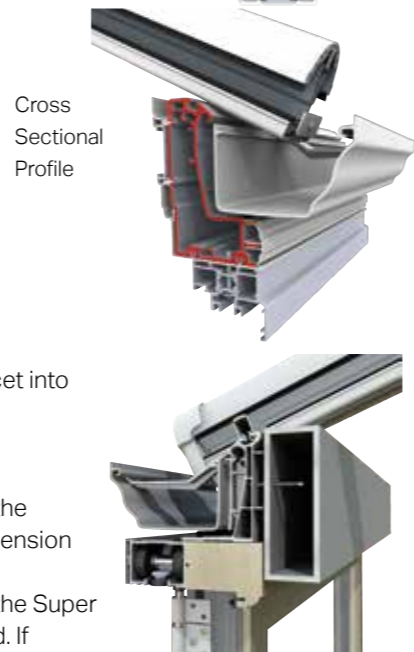

Eaves beam charts - Refer to page 30 of Classic Surveyors Guide for spanning performance.

If the loading conditions are more onerous than the Super Duty Eaves Beam can cater for, a goalpost arrangement is then specified.

Goalpost

- Aluminium header beam and leg post
- Lightweight for fast and easy installation
- Sits behind the eaves beam for a minimalist look
- Internal pelmet option available
- Easy to order with your roof

Footplates

Welded footplate supplied as standard. Base plates are provided with 4 pre-drilled holes for bolting down and 4 pre-drilled holes for fixing to the post. The post can be fixed centrally or at the corner on site.

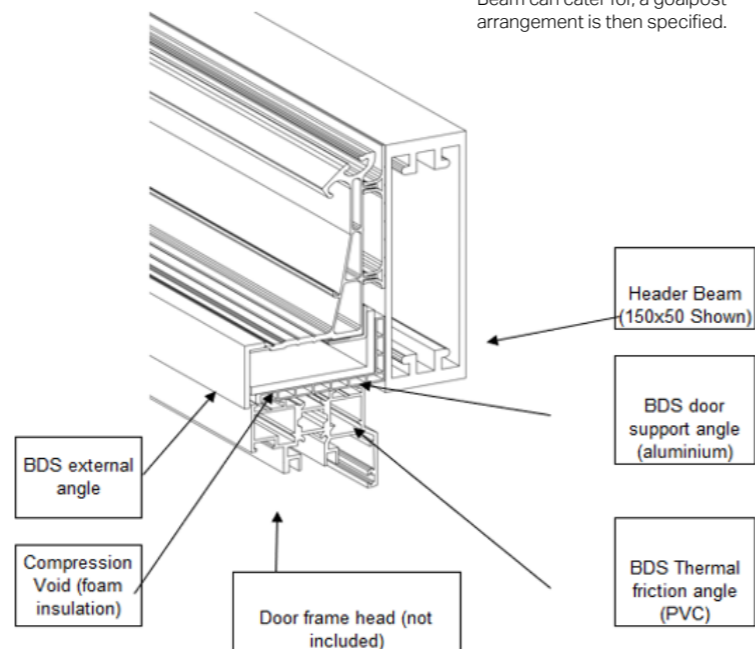
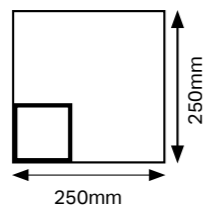

Choosing the right Goalpost for large door spans

If the large door span is parallel to the ridge please use chart A and if it is perpendicular to the ridge, please use chart B.

Goalpost
by Ultraframe

Chart A

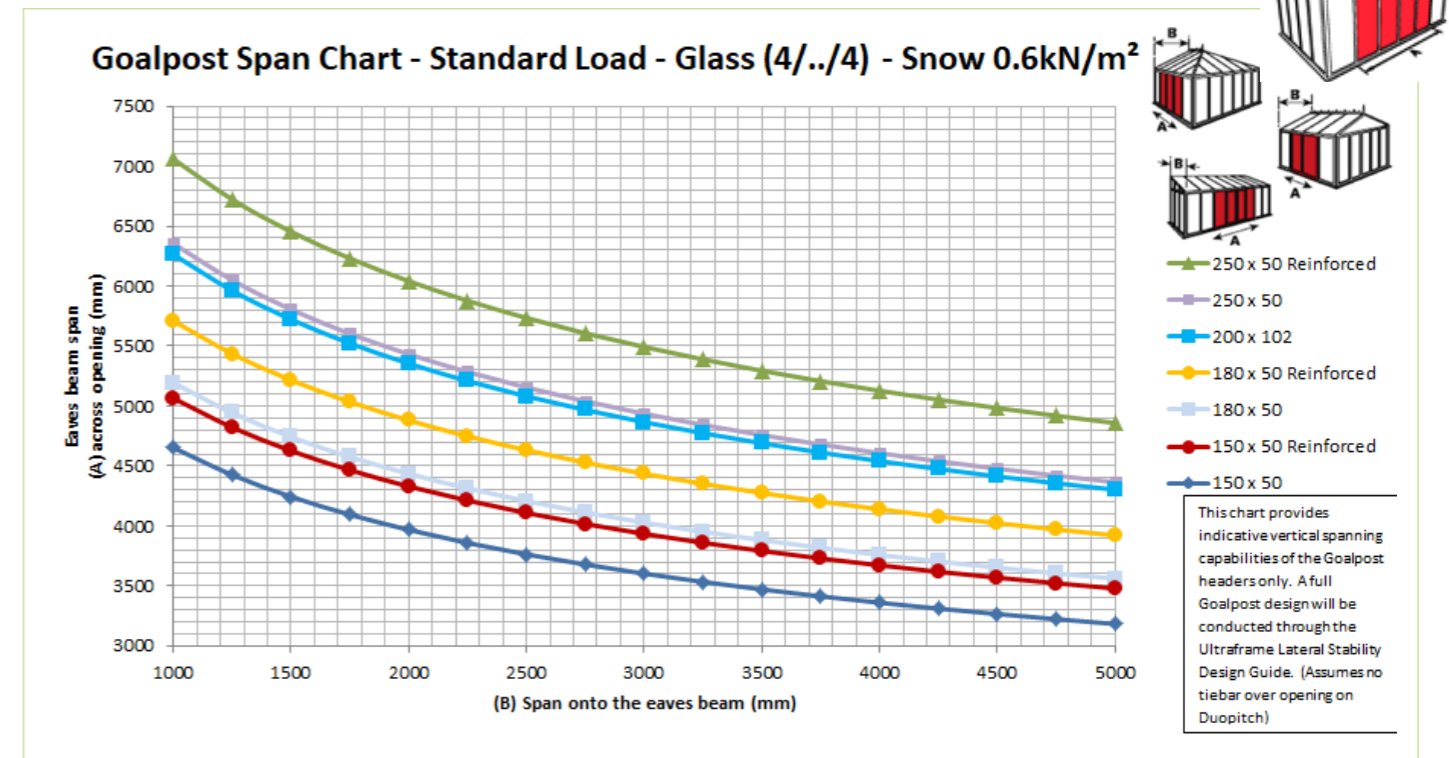
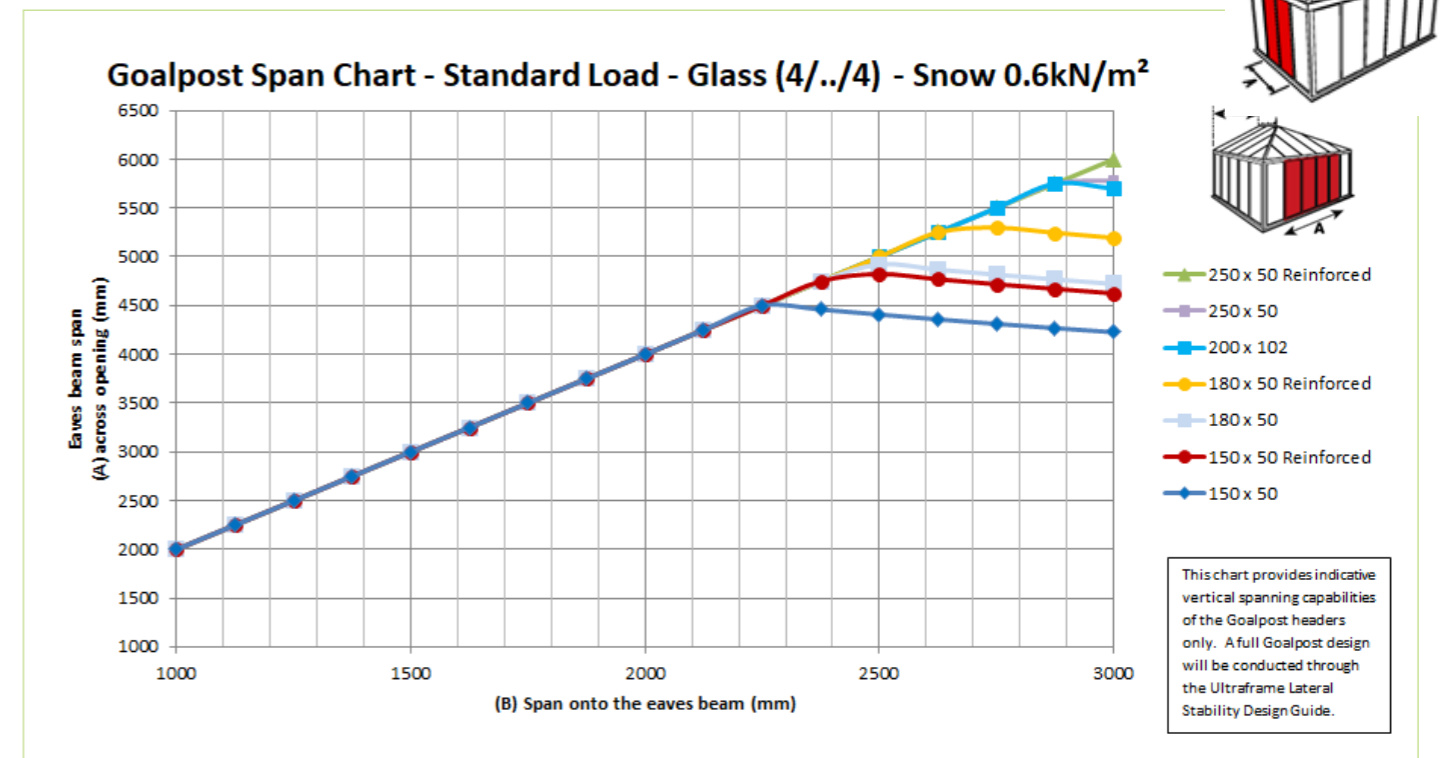

Chart B



Choosing the right Goalpost for large door spans

If the large door span is parallel to the ridge please use chart A and if it is perpendicular to the ridge, please use chart B.



Chart A

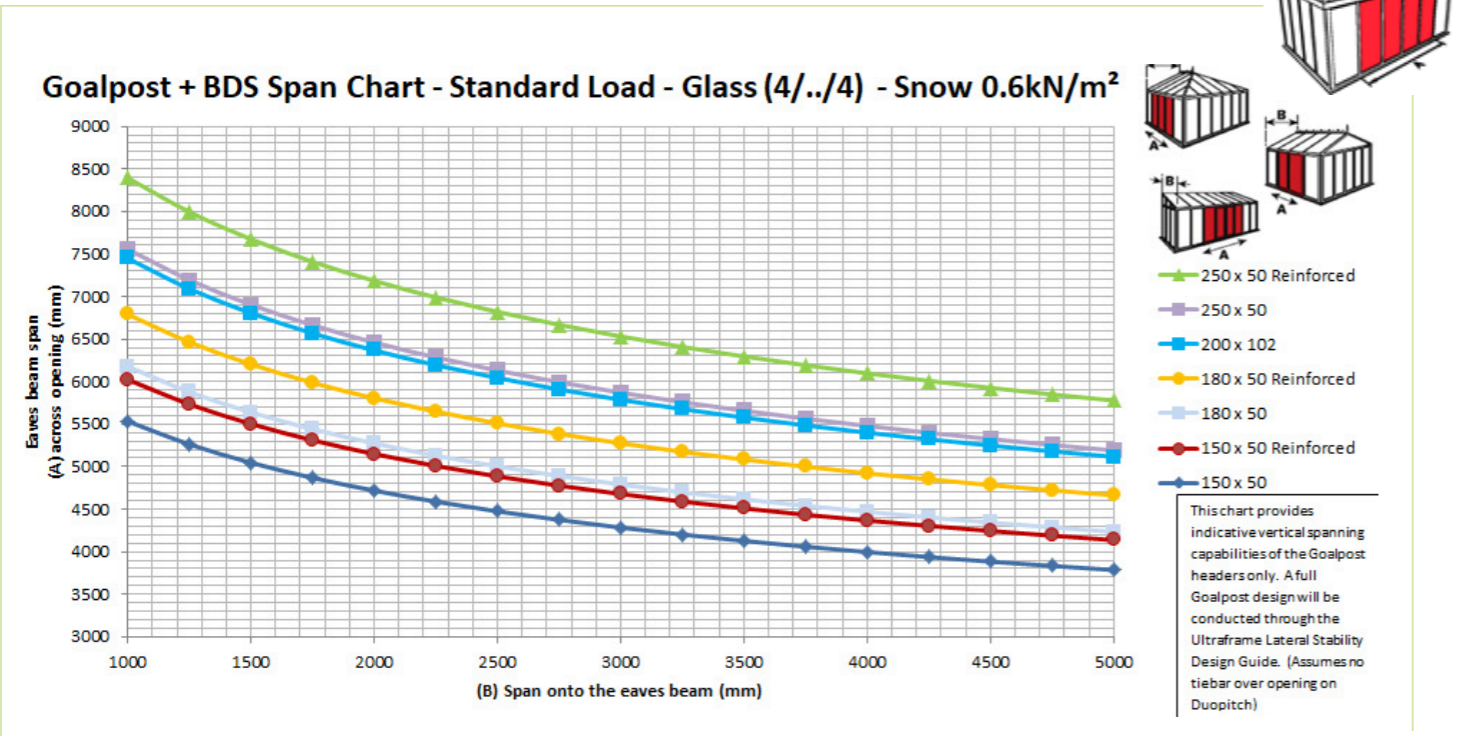
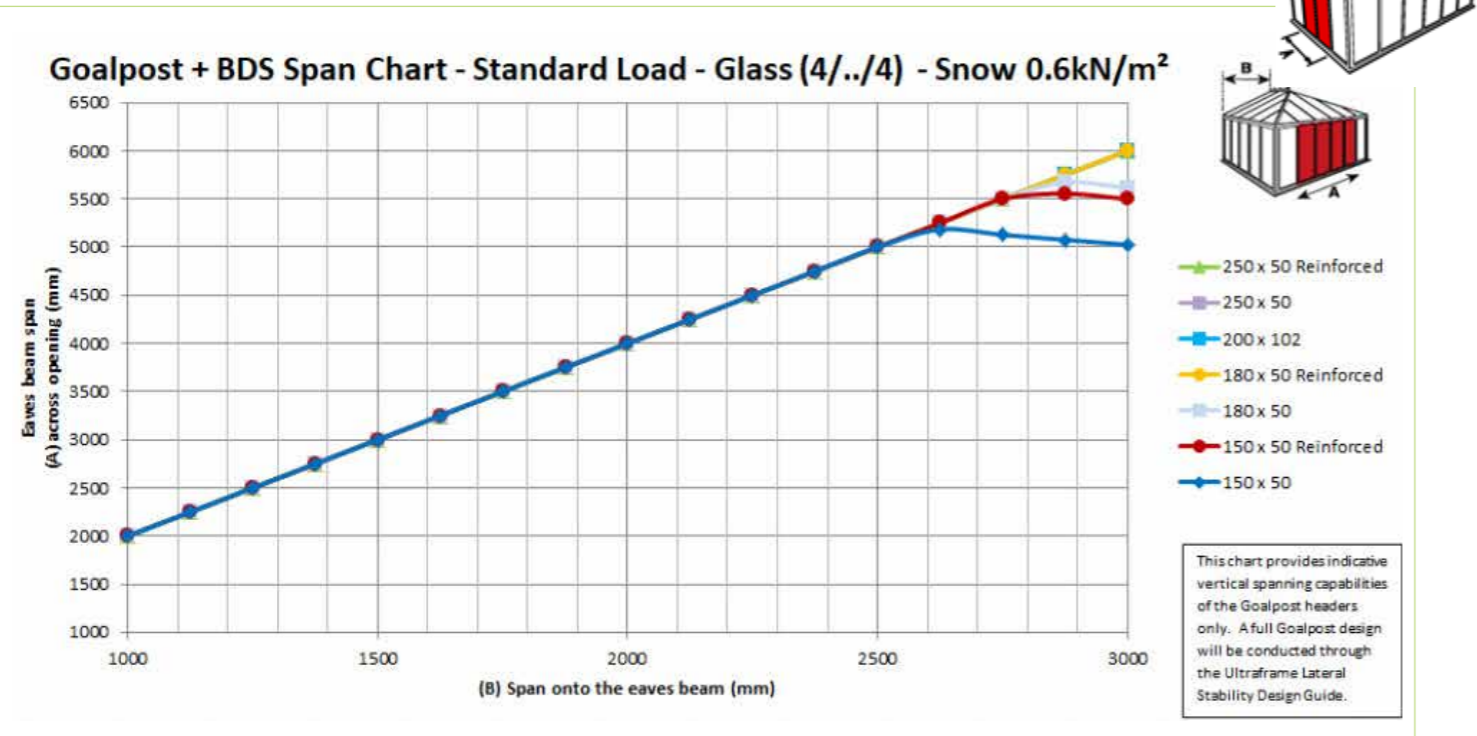

Chart B



These span charts provide indicative vertical spanning capabilities of the Goalpost header beams only. A full Goalpost design will be conducted through the Lateral Stability Design Guide. They assume that there is no tie bar over an opening on Duopitch roofs.

CHOOSING THE RIGHT BEAM FOR LARGE DOOR SPANS

If you decide to use large door spans in your building design, you can determine which eaves beam reinforcement you require using the span charts below.

Eaves beam reinforcements can be used with both Glass Roofs and Livinroofs, but the loads of each system is different. Use either the Glass Roof or the Livinroof charts.

Standard Eaves and Super-duty Eaves are different eaves beam systems that need to be used on all elevations, however the Bi-fold Support Beam (BFS), Eaves Super Bolster (ESB), Combined Bolstered Eaves (CBE) and Goalposts are added to Standard Eaves and therefore are only needed on the elevation with the large span.



Chart A

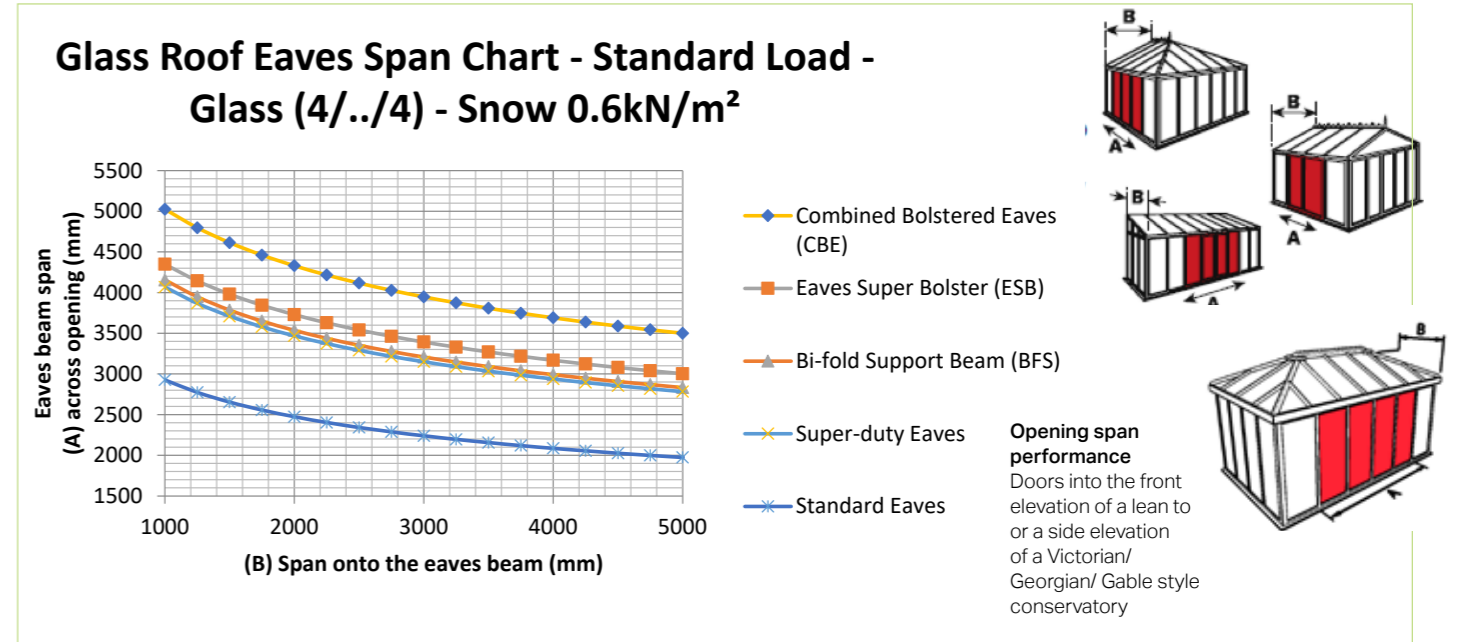
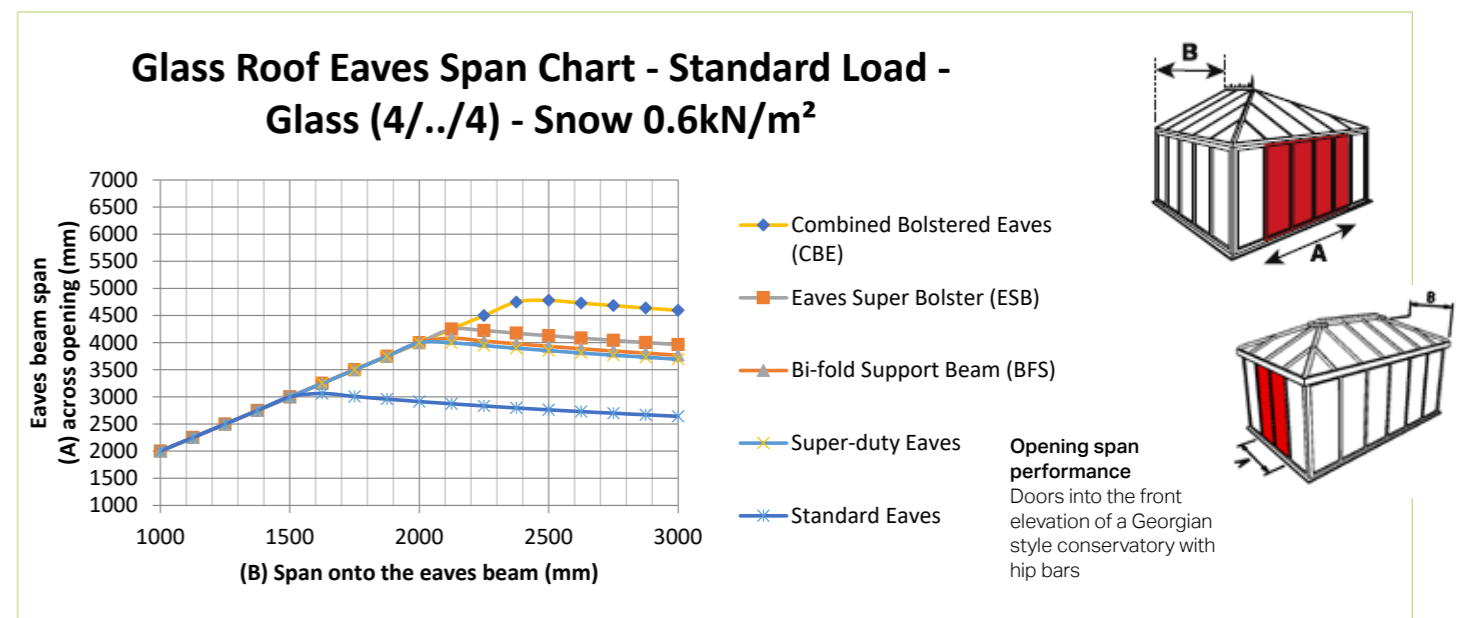

Chart B



Disclaimer: Please note these span charts only indicate which eaves beam reinforcement is required to manage the downward deflection and load on the doors. They do not take into account any information about the building structure and its ability to withstand any lateral forces. Please refer to page 3 regarding structural support for lateral forces.

APPENDIX 4 - SUPER DUTY EAVES BEAM

Structural Span Performance

1. Opening span performance

Doors into the front elevation of a Lean to or a side elevation of a Victorian/Georgian/Gable style conservatory

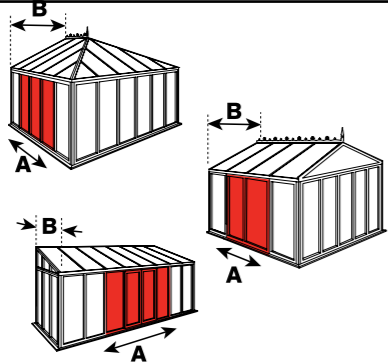

Super Duty Eaves Beam
Eaves Span Chart - Standard Load - Glass (4/.4) - Snow 0.6kN/m²

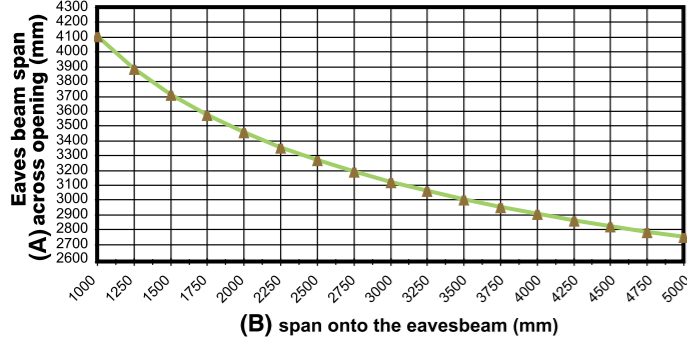

2. Opening span performance

Doors into the front elevation of a Georgian style conservatory with hip bars

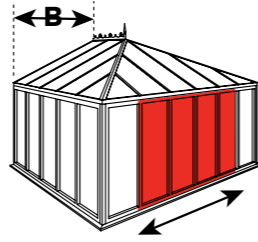

Super Duty Eaves Beam
Eaves Span Chart - Triangular Load - Glass (4/.4) - Snow 0.6kN/m²

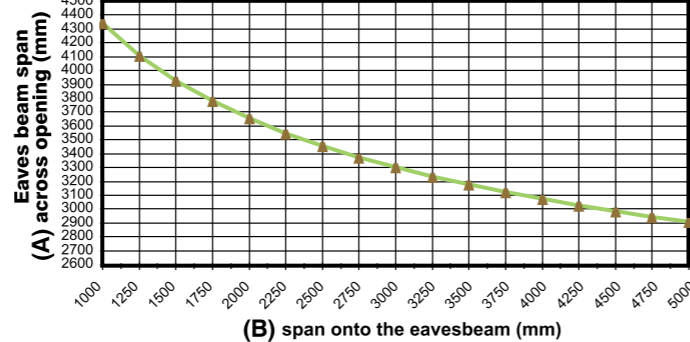

3. Opening span performance

Doors into the front elevation of a Gable style conservatory

This style uses the established Gable Support Beam for doors in the front and standard eaves beam on the sides. For doors in the sides, use Super Duty Eaves Beam on the sides and preferably, Gable Support Beam on the front - cost accordingly

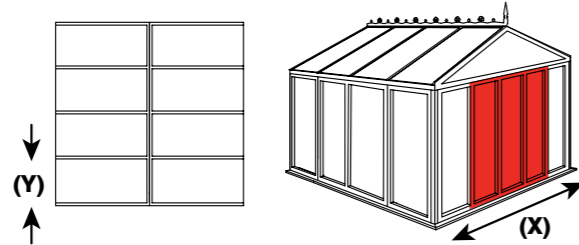

Example -

For a Gable conservatory with a width of 4000mm (X), a roof pitch of 25° and with 750mm distance to the first glazing bar (Y), the maximum opening span for the doors would be 2900mm.

Available unsupported span of Gable Eaves Beam (0.6kN/m² snowload and 4/.4mm glass units)

PITCH	FIRST BAR CENTRE (Y)	WIDTH OF GABLE (mm) (X)																
		1000	1250	1500	1750	2000	2250	2500	2750	3000	3250	3500	3750	4000	4250	4500	4750	5000
15°	1000									2900	2800	2750	2700	2650	2600	2550	2500	2450
15°	750									3100	3050	2950	2900	2900	2850	2800	2750	2700
15°	600										3250	3200	3100	3050	3000	2950	2900	2900
20°	1000									2900	2800	2750	2700	2650	2600	2550	2500	2450
20°	750									3100	3000	2950	2900	2900	2850	2800	2750	2700
20°	600										3250	3200	3100	3050	3000	2950	2900	2900
25°	1000									2900	2800	2750	2700	2600	2550	2500	2450	2400
25°	750									3100	3000	2950	2900	2900	2800	2750	2700	2700
25°	600										3250	3150	3100	3050	3000	2950	2900	2900
30°	1000									2850	2800	2750	2650	2600	2550	2500	2450	2400
35°	1000									2850	2800	2700	2650	2600	2550	2500	2450	2400
40°	1000									2850	2750	2700	2650	2550	2500	2500	2450	2400

All configurations in the shaded area have an opening span the full width of the conservatory

www.ultraframetrade.co.uk

Job No: 3714 08/24 V15 LVL002

It is Ultraframe's policy to continually seek to improve its products, processes and services, and we reserve the right to change specifications without prior notice. Ultraframe is a trading name of Ultraframe (UK) Limited.

Ultraframe[®]
Transforming light and space

